



# IA-HEV Task 20 “Quick Charging Technology”

Final report

2012 - 2015



---

**Authors:**

**Ignacio Martín Jiménez**

**Carlos Arsuaga Carreras**

**Gregorio Fernández Aznar**

**José Francisco Sanz Osorio**

**- CIRCE (Spain) -**

**Remark:**

Task 20 “Quick Charging” of the “Implementing Agreement for Hybrid and Electric Vehicles” (IA-HEV), functions within a framework created by the International Energy Agency (IEA). Views, findings and publications of Task 20 do not necessarily represent the views or policies of the IEA Secretariat or of all its individual member countries.

**Acknowledgments:**

The lead authors would like to thank all supporting contributions to Task 20 on “Quick Charging” of the Hybrid and Electric Vehicles Implementing Agreement of the International Energy Agency. These include Tony Markel and Ahmad Pesaran from the National Renewable Energy Laboratory of the USA, Michael Nicholas from University of California Davis, Hiroshi Horie from Nissan, James Barnes from the Department of Energy and Tomohisa Maruyama from the Ministry of Economy, Trade and Industry of Japan.

Special acknowledge to the Governments of Germany, Ireland, Spain and the United States for their support to this task, as well as to the IEA. The authors also gratefully thank all the organizations that participated in the activities carried out under the umbrella of the Task 20, such as the physical meetings and the online survey.

## Content

<b>1. Introduction .....</b>	<b>5</b>
<b>2. Quick Charging Technology: State of the Art.....</b>	<b>8</b>
2.1. CHAdEMO .....	11
2.2. Combined Charging System (CCS).....	15
2.3. CHAdEMO versus COMBO .....	20
2.4. Other quick charging technologies: inductive charging .....	21
<b>3. Impact of the quick charging on the electrical grid .....</b>	<b>24</b>
3.1. Impact on grid quality .....	24
3.2. Grid overload .....	25
3.3. Solutions to reduce the impact of quick charging to the grid .....	26
<b>4. Impact of the quick charging on the battery .....</b>	<b>32</b>
<b>5. Business models for quick charging .....</b>	<b>37</b>
Possible options for a successful business case for QC.....	41
<b>6. Vehicle-to-grid (V2G) .....</b>	<b>46</b>
<b>7. Situation of Quick Charging Technology .....</b>	<b>50</b>
7.1. Approaches and goals in the development of charging infrastructures worldwide.....	51
7.2. Actions at EU level.....	55
7.3. Specific national programmes .....	56
Estonia.....	57
Ireland .....	57
United States.....	59
Japan.....	60
7.4. Future of Quick Charging technologies.....	61
<b>ANNEX 1: IEA SURVEY RESULTS .....</b>	<b>63</b>
<b>PART 1: BUSINESS MODELS .....</b>	<b>63</b>
<b>PART 2: CHARGER INFRASTRUCTURE .....</b>	<b>64</b>
<b>PART 3: OEM .....</b>	<b>65</b>
<b>PART 4: GRID IMPACT .....</b>	<b>66</b>
<b>LIST OF PARTICIPANTS IN THE QUICK CHARGING SURVEY.....</b>	<b>68</b>
<b>ANNEX 2: RELEVANT STANDARDS FOR QUICK CHARGING.....</b>	<b>69</b>

## **List of Acronyms**

AC – Alternating Current  
ACEA – Association des Constructeurs Européens d'Automobiles (European Automakers Association)  
BMS – Battery Management System  
CAN – Controller Area Network  
CCS – Combined Charge System  
DC – Direct Current  
DSO – Distribution System Operator  
EV – Electric Vehicle  
EVI – Electric Vehicles Initiative  
EVSE – Electric Vehicle Supply Equipment  
IA-HEV – Implementing Agreement – Hybrid and Electric Vehicle  
ICPT – Inductive Coupling Power Transfer  
IEA – International Energy Agency  
OCPP – Open Charge Point Protocol  
OEM – Original Equipment Manufacturer  
PEV – Plug-in Electric Vehicle  
PLC – Power Line Communication  
QC – Quick Charging  
RFID – Radio Frequency Identification  
SAE – Society of Automotive Engineers  
V2B – Vehicle-to-Building  
V2C – Vehicle-to-Community  
V2G – Vehicle-to-Grid  
V2H – Vehicle-to-Home  
V2V – Vehicle-to-Vehicle  
WPT – Wireless Power Transfer

## 1. Introduction

This document intends to present the main results of the work carried out within the IEA IA-HEV Task 20 on “Quick Charging Technologies” in its three-years and a half lifetime. The Task was approved on November 11<sup>th</sup>, 2011, at the 35<sup>th</sup> IA-HEV Executive Committee meeting in Lisbon, Portugal, and run through May 2015. Its main goal was to promote solutions and improvements in order to enable a broad penetration of this technology.

Through having objective discussions based on facts, and sharing knowledge about the development and trends for quick charging technologies, Task 20 participants have had access to very up-to-date information from car manufacturers, utilities (distribution system operators – DSOs), battery companies, government representatives, and equipment manufacturers.

Specific topics addressed were:

- Quick charging technology development trends worldwide
- Outcomes from the latest quick charging pilot projects and the issues to be resolved
- Lessons learned from past charging network deployment plans
- Impact of quick charging on PEV battery ageing and behaviour
- Different charging infrastructure options (e.g., specific charging stations that can charge one or many cars in private or public locations)
- Relationship between the energy efficiency and the charge power of the charging station
- Trade-offs between the shortest time to a full charge and the charger cost
- The need for quick chargers and public charging stations to counter range anxiety
- Quick charging solutions that will help to popularize EVs
- Issues in the relationship (technical and socioeconomic) between the PEV and the grid, including power quality, tariffs, regulations, incentives, etc.
- To analyse and propose the best technical solutions for interoperability and the optimum use of the electric infrastructure already in place
- How emerging technologies (smart grids and EVs) can join efforts to accelerate their market penetration
- The requirements and issues of quick charging technology for future smart grid promotion

The Task 20 based its exchange of information and interactions on regular face-to-face meetings with the presence of key experts from the main quick charging stakeholders worldwide. After the kick off meeting in conjunction with the EVS26 hold in Los Angeles (United States), the Task organized 3 thematic meetings in Nagoya and Tokyo (Japan), Barcelona (Spain) and Nice (France).

The Task was officially kicked-off in May 6, 2012 in Los Angeles, California, and was attended by around 40 people from a wide range of stakeholders worldwide. The main goal of this meeting was to identify the main challenges and barriers of the framework for quick charging market growth.

Task 20 held its second technical exchange workshop across two cities in Japan on June 3–5, 2013. The goal was to discuss the progress in the development and deployment of DC quick charging (QC) technology in Japan, Europe, and the United States (U.S.). Japan's Ministry of Economy, Trade and Industry (METI) helped to organize the meeting.

A total of 39 experts from the U.S., Germany, China, Spain, and Japan participated in that meeting, representing automotive original equipment manufacturers (OEMs), charging equipment providers, research centres, utilities, and government.

Late 2013, and again in conjunction with the EVS27, a specific workshop with special focus on interoperability as a trigger for a larger deployment of QC was organized in Barcelona (Spain). More than 30 participants from 6 countries were present representing different entities with key roles in the whole interoperability chain from public and private sides. Main items of the agenda where:

- EV ↔ EVSE compatibility (non-exclusive customers, variety of manufacturers... an issue even after standardization)
- Harmonized EV-grid communication ("roaming"-capabilities, management of identification, billing and load)
- Co-existing legacy and advanced systems (situation in countries varies a lot e.g., in smart metering)

The last meeting of the Task was organised together with Task 10 on Electrochemistry of the IA-HEV in the framework of the international Batteries 2014 congress in Nice on September 22-23. The workshop was focused on the effects of the quick charging on batteries in PEV. The meeting was attended by a number of internationally acclaimed research groups, public authorities, vehicles manufacturers and battery manufacturers.

On the other hand, IA-HEV Task 20 "Quick Charging Technology", posted an online questionnaire to solicit input from the electric vehicles community on the current status and future applications of QC technology. The survey covered potential business models for DC QC as well as issues in its value chain, including charger infrastructure, OEMs and interoperability, the impact of DC QC on the electricity grid, and the anticipated timeframe for developments in technology and regulatory frameworks.

The motivation for the survey is to answer issues that need to be addressed in order to facilitate more widespread deployment of DC QC technology, targeting a larger audience aside from the participants that attended the physical meetings. Over 50 organizations from more than 10 different countries in Europe, Asia and America have responded to the survey. These organizations cover all possible QC stakeholders:

OEMs, charger providers, utilities, public administrations, academia... The figures below show the distribution of these answers by country and type of organization:

**Figure 1:** Participants of the survey per country

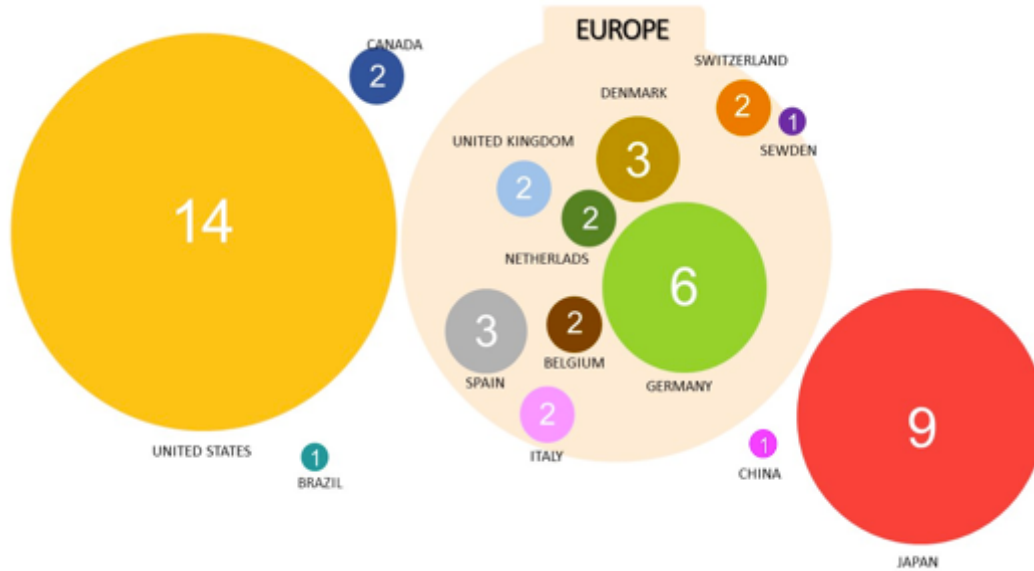

Source: IEA Task 20 Survey

**Figure 2:** Participants of the survey per type of organization



Source: IEA Task 20 Survey

The information presented in this document comes from all the discussions that took place at the physical meetings, the documents gently provided by the collaborators and the online survey.

## 2. Quick Charging Technology: State of the Art

The wide deployment of the electric vehicle is linked to the development of the associated infrastructure for recharging the EV batteries. Different recharge possibilities exist, described by standard IEC 61851-1 in 4 different modes considering factors such as output power, control and protection equipment or connection type. A brief summary of each charging mode is presented in table 1 and figure 3:

**Table 1:** Charging modes for electrical vehicles

	Mode 1		Mode 2		Mode 3		Mode 4
<b>Grid Connection</b>	16 A plug (Type A, B & C)		Standardized outlet (Type A, B & C)		EV connected directly to the grid by means of a Charging Post (Type A, B & C)		EV connected indirectly to the grid by means of a Charging Post (Only type C)
<b>Device for regulating the charging</b>	On board EV		On board EV		On board EV		Off board EV
<b>Recharging system permanently connected to the grid</b>	---		No		Yes		Yes
<b>Communication</b>	Not necessary		Pilot control wire compulsory		Communication between vehicle and post compulsory		Communication between vehicle and post compulsory
<b>Phases Number</b>	I	III	I	III	I	III	DC
<b>Maximum Power (kW)</b>	3,7	11	7,4	22	16,1	44	240
<b>Maximum current</b>	16 A (IEC 61851-1)		32 A (IEC 61851-1)		63 A (III) 70 A (I)		400 A (DC)

Source: IEC 61851



Figure 3: Charging modes for electric vehicles (II)

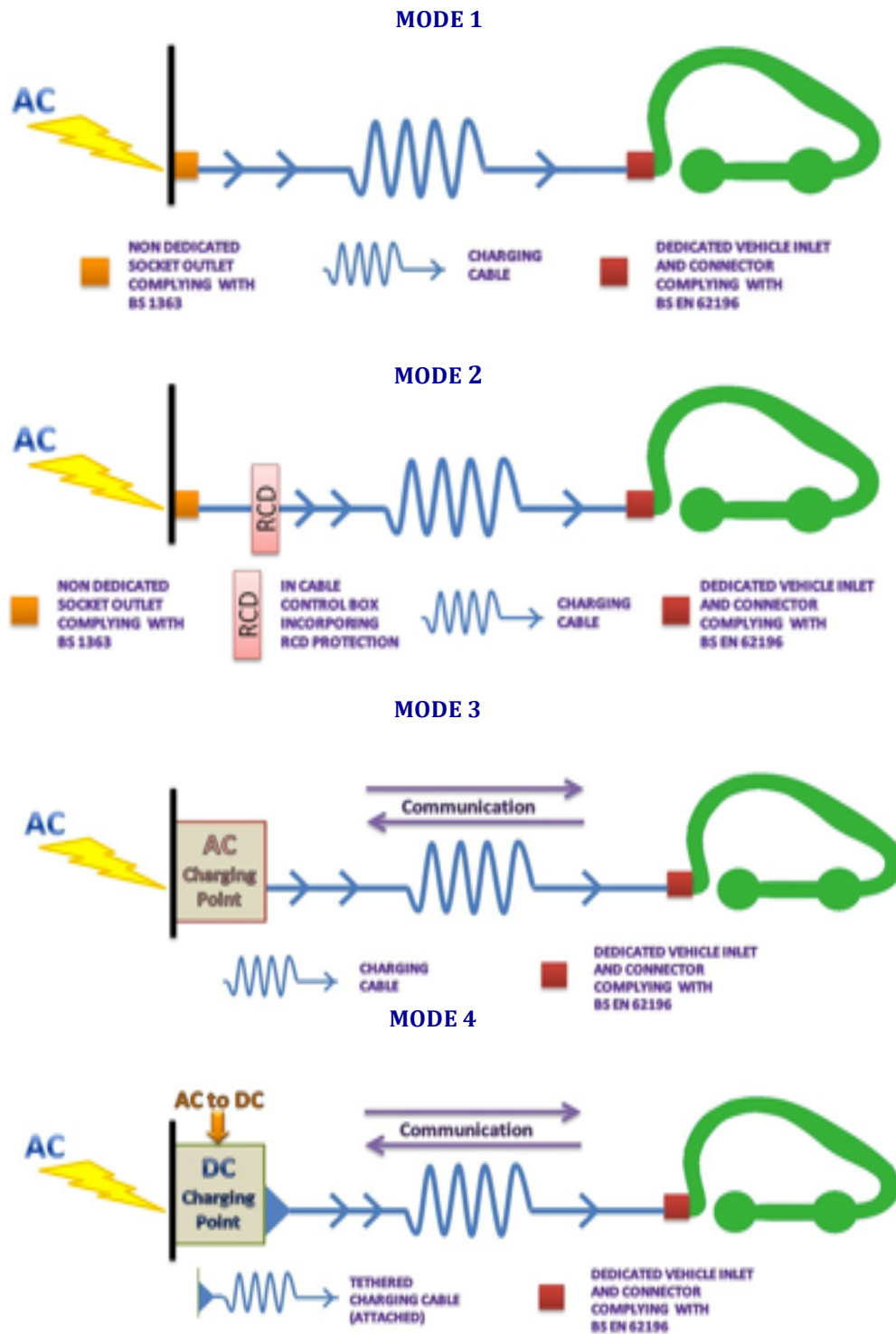

Source: EV Charging Point

Mode 1 has been traditionally used for charging processes using standard alternating current (AC) mains socket (current 16 A) when using the necessary protections (earth leakage and circuit breakers). However, this charging mode implies very long battery recharging times (6 to 8 hours). This is not a problem if the charging process takes place

at home or workplace, when vehicles are stationed for a long time, but it might be an issue for long distance trips or when the vehicle is parked for little time.

In order to solve this challenge, quick (or fast) chargers allow the EV owner to charge the batteries in a very short time (80% of battery capacity in 15-20 minutes<sup>1</sup>) when needed, in a similar way than the current gas stations for combustion vehicles, thus solving one of the main barriers for a massive deployment of EVs: the range anxiety. This is shown in figure 4.

**Figure 4:** EV battery charging times for different vehicles and charger output power

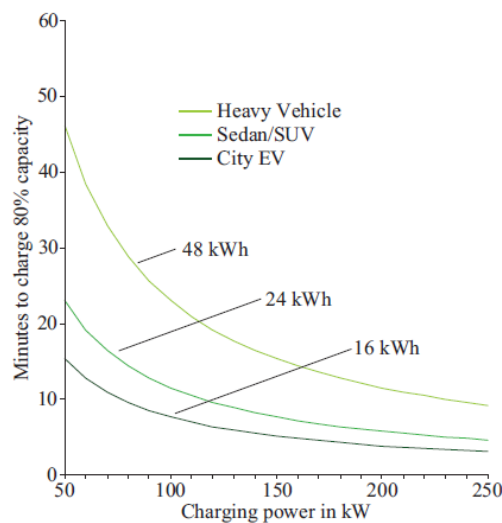

Source: D. Aggeler, F. Canales, H. Zelaya - De La Parra, A. Coccia, N. Butcher, and O. Apeldoorn, "Ultra-Fast DC-Charge Infrastructures for EV-Mobility and Future Smart Grids", Innovative Smart Grid Technologies Conference Europe (ISGT Europe), IEEE PES, 2010.

Nowadays, most quick charging technologies available in the market supply the electricity to the EV battery in direct current (DC). Due to the high levels of voltage and current in QC, the recharging process is made through an external charger that transforms the AC of the distribution grid to DC suitable for recharging the EV battery pack, in opposition to slow and medium charging where this process is made in the on-board charger of the vehicle (limited to 240 V<sub>AC</sub> and 75 A due to cost and thermal issues).

A figure summarizing the main issues of DC QC is presented in the section below. Most of these issues have been discussed in the physical meetings held during the life of Task 20 and are further developed and explained in this document.

<sup>1</sup> This time corresponds to 50 kW chargers, for chargers able to supply higher power (mode 4 allows up to 240 kW) the charging times are much lower, as shown in figure 4.

## Current state and framework of DC Quick Charging Technologies

Figure 5: SWOT analysis of DC quick charging technologies

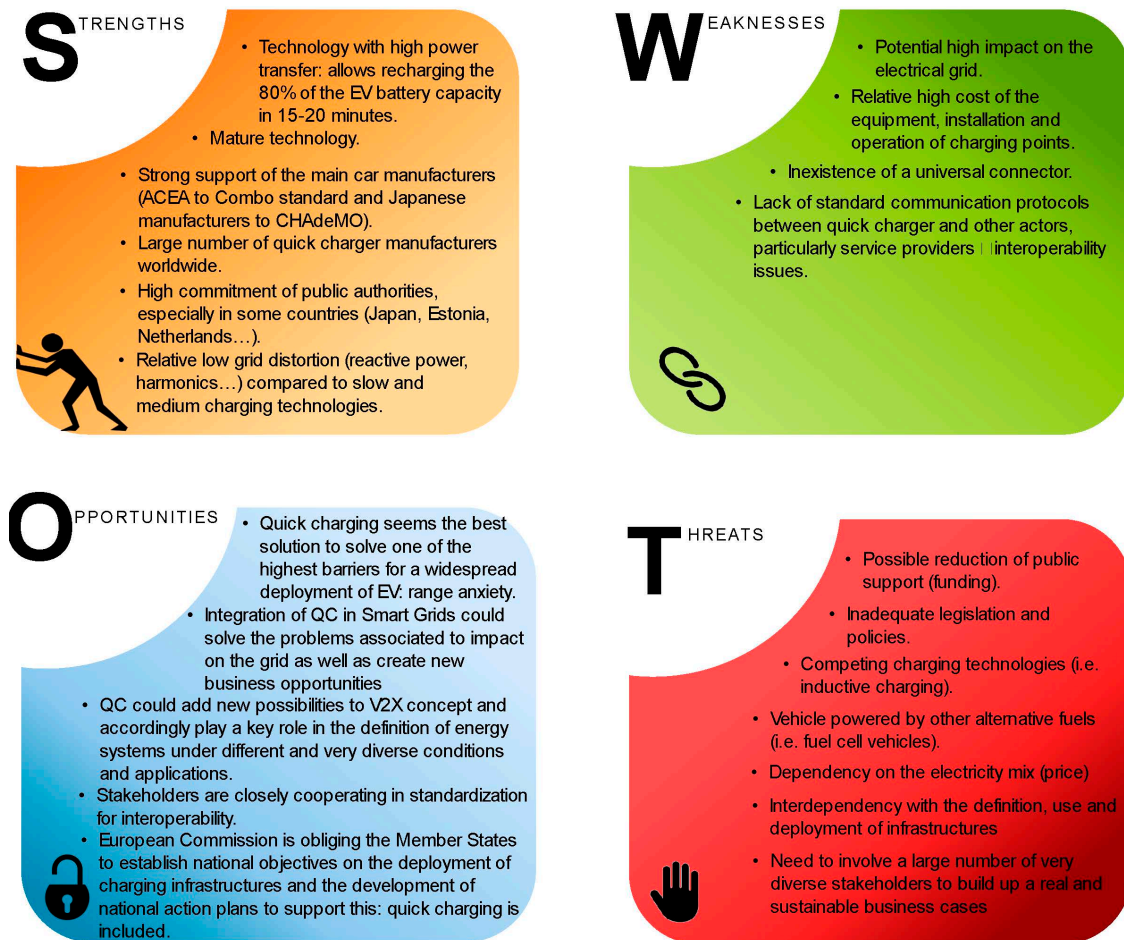

Source: CIRCE from data collected in IEA Task 20 Survey and meetings

There are basically two industrial widespread standards in the world for DC quick charging: CHAdeMO and Combined Charge System (CCS)<sup>2</sup>. In the following subsections, the main features and differences between both standards are presented.

### 2.1. CHAdeMO

The CHAdeMO was the first DC QC method in the world, originally developed in 2010 by the electric companies Tokyo Electric Power Company (TEPCO) and Fuji Heavy Industries and the car manufacturers Nissan and Mitsubishi; Toyota joined later as the

<sup>2</sup> Tesla has its own DC quick charging standard (Supercharger) with more than 200 chargers deployed in North America, Europe and Asia, but it's not clear how many charging stations this represents. Tesla technology is not taken into account in this document, since the company has not participated in the Task and its technology is limited to one manufacturer.

China, on the other hand, has developed a national GB standard for DC fast charging and even some manufacturers, like ABB, offer China GB compliant products. However, this standard is still subject of disagreement among Chinese authorities and some sources state that a formal DC standard will not come out in China until 2016.

fifth executive member. Even though CHAdeMO has a Japanese origin, nowadays companies from all over the world are committed to this standard, as proved by the fact that CHAdeMO is the most extended method for DC quick charging in the world. Overall, more than 430 organizations (Energy companies, EV OEMs, charger manufacturers, municipalities...) from 26 countries around the world are represented in the CHAdeMO association today.

Indeed, not only the Japanese vehicle manufacturers that participated in the development of CHAdeMO have adapted their EVs to this standard (Nissan Leaf or Mitsubishi iMIEV) but also manufacturers from other regions in the world, such as Peugeot (Peugeot ION) or Citroën (Citroën c-ZERO). Furthermore, charger manufacturers from the US, Europe and Japan have developed chargers that comply with CHAdeMO specification. Actually, CHAdeMO set up a certification system in 2010 (the only certification system for quick charge in the world) to ensure the interoperability between chargers and vehicles. The certification process consists of five steps<sup>3</sup> and involves a basic circuit requirement, control sequence and communication protocol. There are currently only five bodies accredited by CHAdeMO to conduct certification tests: Idiada (Spain), UL Japan (Japan), TÜV Rheinland Japan (Japan) and TERTEC (Taiwan). The number of certified models<sup>4</sup> has reached 100 between the two existing versions (0.9 and 1.0). However, even though the chargers are bounded and or certified, some compatibility issues occurring in the field have been reported in the past. This subject is further developed in page 19.

Some examples of charger manufacturers that participated in the discussions of Task 20 and whose models have obtained the CHAdeMO certification are: ABB (Switzerland), AeroVironment (USA), Hitachi (Japan), GH Electrotermia (Spain) or Aker Wade (USA).

**Figure 6:** CHAdeMO chargers



Source: Aker Wade, GH Electrotermia, ABB and Hitachi

All these quick chargers include a series of features that differentiates one from each other, such as the user interface, measures against vandalism, devices to suppress

<sup>3</sup> (1) Application for CHAdeMO regular member, (2) Product development, (3) Submission of application form, (4) Certification test and (5) Receive certificate

<sup>4</sup> A complete list of all the CHAdeMO-certified charger models and their specifications can be found in CHAdeMO website: [http://www.chademo.com/wp/wp-content/uploads/2014/10/Certified\\_charger](http://www.chademo.com/wp/wp-content/uploads/2014/10/Certified_charger)

harmonics, unit configuration, the possibility or not of selecting the output power, use restriction to reduce occupation time per user, etc.

As mentioned before, CHAdeMO is the most widespread quick charging system in the world: as of May 2015, there were 5,737 CHAdeMO charging points installed all around the world, of which 3,087 in Japan, 1,661 in Europe, 934 in the USA and 55 in other countries (basically Canada). The evolution of the number of charging stations in Japan and the rest of the world has been very positive, despite the appearance of another competitive and incompatible QC system (CCS) in 2013, as shown in the figure below:

**Figure 7:** Evolution of CHAdeMO charging points in the world (Nov'09 – Mar'15)

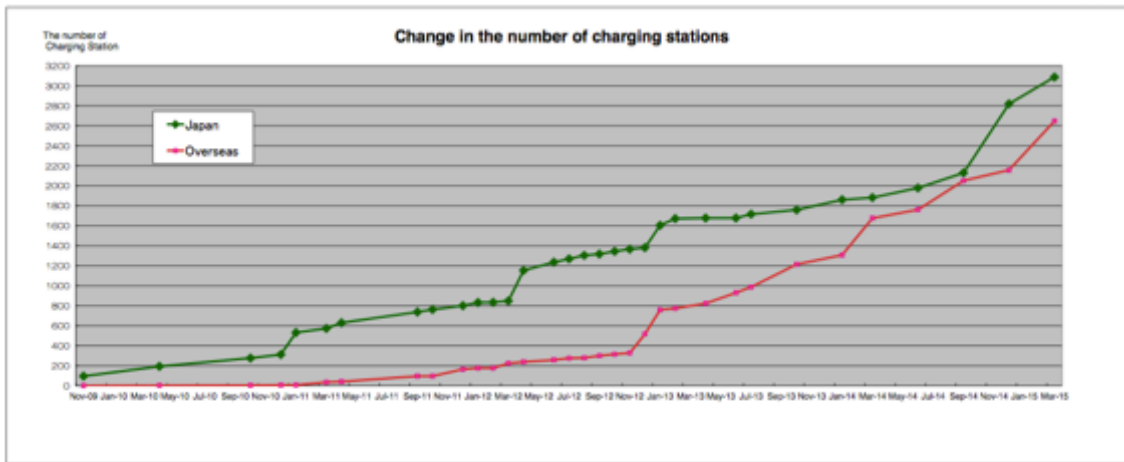

Source: CHAdeMO

A more detailed distribution of the CHAdeMO chargers deployed across Europe is shown in the map below, with the Northern countries scoring the highest on charger density per population:

**Figure 8:** CHAdeMO compliant chargers in Europe as of July 2014

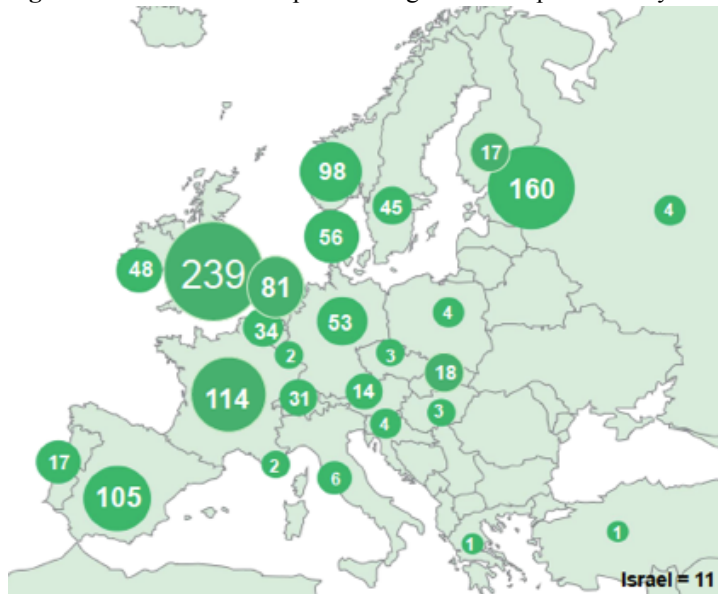

Source: CHAdeMO

CHAdEMO has a communication protocol between the charger and the vehicle (named CHAdEMO protocol) using CAN bus, which is the preferred on-board communication network for all EVs as well as combustible cars and has been recognized as the most reliable and proven solution for many vehicle control functions. For quick charging, a dialogue between the EV and the controller of the external charger is established through this communication protocol, in which the EV requests the necessary energy to recharge the battery (indicating specific values of current and voltage) in the appropriate and fastest charging based on the battery performance and usage environment.

Concerning the CHAdEMO connector, its characteristics are defined in the CHAdEMO specifications but they also have to comply with the international standard IEC 62196-3. Its main characteristics are:

**Table 2:** CHAdEMO main characteristics

CHAdEMO connector	
<b>Max current</b>	120 A (DC)
<b>Max voltage</b>	500 V (DC)
<b>Max power</b>	50 kW
<b>Max current (control system)</b>	7 A (DC)
<b>Max voltage (control system)</b>	12 V (DC)
<b>Communication protocol</b>	CHAdEMO
<b>IP Level</b>	44 (connected)

Source: CHAdEMO

CHAdEMO standard only specifies the part of the connector that effectively connects with the EV (i.e. the interface), as shown in figure 9, the design of the rest of the connector depends exclusively on the manufacturer.

**Figure 9:** CHAdEMO connector dimensions and pin configuration

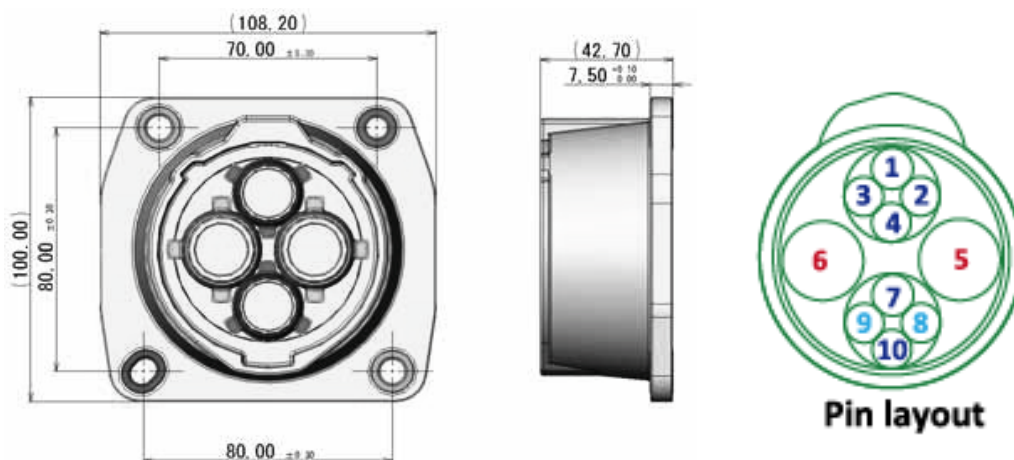

Source: CHAdEMO

In order to ensure an effective connection for both the power and control parts of the charging station and the EV, a specific physical configuration of the connector (defined

in the CHAdeMO standard) is necessary. For the power circuits (pins 5 and 6), 35 mm diameter cables are used (2x35), whereas the cables utilized for the communication signals are much thinner: 0.75 mm (7x0.75), in the configuration shown in the previous figure. A summary of all the pins of the CHAdeMO connector is shown below:

**Table 3:** CHAdeMO connector pin specifications

Pin nº	Colour	mm <sup>2</sup>	Name of the pin
1	Black	0.75	Ground
2	Green	0.75	Start/ stop charging
3	White		None
4	Brown	0.75	Permission/ Prohibition charging
5	Black	22 o 40	Energy supply negative
6	White	22 o 40	Energy supply positive
7	Blue	0.75	Verification of the connector connection
8	Orange	0.75	CAN-H
9	Red	0.75	CAN-L
10	Pink	0.75	Start/ stop charging 2

Source: CHAdeMO standard

As stated before, these are the only specifications related to the connector defined by CHAdeMO. Some example of commercial CHAdeMO-compliant connectors manufactured by different companies are presented below, in order to show the differences in the design and components that form them:

**Figure 10:** CHAdeMO connectors



Source: CHAdeMO

## 2.2. Combined Charging System (CCS)

In parallel to CHAdeMO, several American and, particularly, European companies, such as Audi, BMW, Daimler, Ford, General Motors, Porsche or Volkswagen, started developing a new system for quick charging: the Combined Charging System (CCS) or COMBO. The main goal behind this initiative, strongly supported by SAE and ACEA, was to develop a one “global envelope” that permits the recharging of the vehicle both

in AC (slow/medium charging) and DC (quick charging) using two types of charger connectors and only one charging inlet in the vehicle.

This is an important difference with the CHAdeMO standard, since the latter has been only designed for DC quick charging and that is the only charging mode allowed by both the charger connector and the vehicle inlet. An electric vehicle designed to be charged using the CHAdeMO standard needs a separate and differentiated charging socket to be charged using modes 1 to 3 (AC), with the corresponding additional costs that this implies, although it has been a common practice among vehicle manufacturers.

**Figure 11:** Nissan Leaf charging sockets: CHAdeMO (left) and ISO61196-2 Type 1 (right)



Source: Nissan

Two models of COMBO connectors have been developed based on the AC part of the connector: the so called COMBO 1, for the United States, adopts a type 1 connector (as specified by the standards SAE J1772/ UNE EN 62196-2) on its upper part; whereas the European version, COMBO 2, integrates type 2 connector as defined in the standard UNE EN 62196-2. The two models are shown in the figure below:

**Figure 12:** Connectors and EV charging socket for COMBO 1 (right) and COMBO 2 (left)



Source: Phoenix Contact



**Table 4:** COMBO 1 and 2 main characteristics

EV charging socket	Type	Connector	Charging mode <sup>5</sup>
Combo 1 (USA)	AC	Type 1 (IEC 62196-2, SAE J1772)	3
	DC	Combo 1 (IEC 62196-3)	4
Combo 2 (EU)	AC	Type 2 (IEC 62196-2)	3
	DC	Combo 2 (IEC 62196-3)	4

Source: CCS specifications

The following table shows the configuration and functions of the pins in the COMBO 1 connector:

**Table 5:** COMBO 1 pin configuration

	Inlet	Function	Comments
	PP	Communications/charging process control	Proximity inlet
	CP		Control pilot
	PE	Earth ground	EV to earth ground
	N/L2	AC 1-phase charging	Neutral / Phase 2
	L1		Phase 1
	DC -	DC charging	DC negative inlet
	DC +		DC positive inlet

Source: CCS Specifications

Similarly, a table showing the same information for COMBO 2 is included in this document:

**Table 6:** COMBO 2 pin configuration

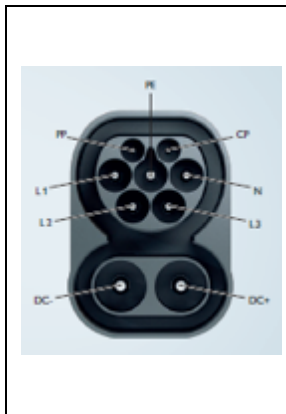
	Inlet	Function	Comments	
	PP	Communications/charging process control	Proximity inlet	
	CP		Control pilot	
	PE	Earth ground	EV to earth ground	
	N	AC 3-phase charging	AC 1-phase charging	Neutral
	L1		-	Phase 1
	L2		-	Phase 2
	L3		-	Phase 3
	DC -	DC charging	DC negative inlet	
	DC +		DC positive inlet	

Source: CCS specifications

Both in COMBO 1 and COMBO 2, the pins PE, PP and CP are common to AC and DC connectors, thus sharing communication as showed in the figure below:

**Figure 13:** Compatibility scheme of COMBO

<sup>5</sup> As defined by standard IEC 61851-1

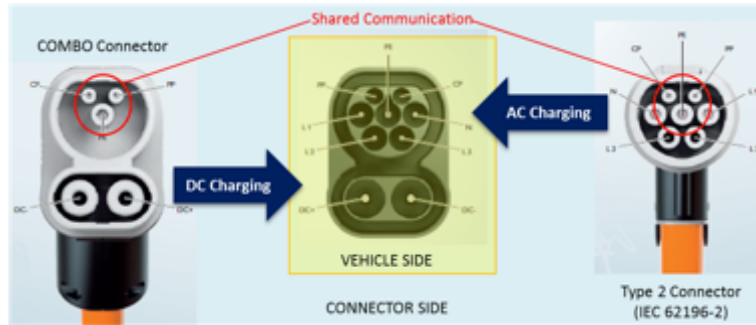

Source: Phoenix Contact

Indeed, at the beginning of 2013, the COMBO standard was not yet completely developed and there was not any charger manufacturing producing COMBO chargers. However, in June 2013, both BMW and Volkswagen successfully deployed the first COMBO charge stations in Germany and that very same year the first vehicles with a DC quick charger socket entered the market. Since then, the number of COMBO charging points has rapidly increased and there are currently more than 750 only in Europe<sup>6</sup> and some manufacturers that promoted this standard have launched car models adapted to this charging system (BMW i3, Chevrolet Spark EV or Volkswagen e-Golf). Moreover, the EU Automakers Association (ACEA) has confirmed that as from 2017, all new vehicle types manufactured by their members will be equipped with COMBO 2-compliant charging socket in the vehicle side. ACEA supports that the Type 2 COMBO should be the long-term EU standard for AC/DC quick charging.

Similarly, a large number of companies started to manufacture equipment following the new standard and many models can be now found in the market. Many of these manufacturers also have CHAdeMO charger equipment in their portfolio, as some of those mentioned in the previous section as collaborators in this Task.

**Figure 14: COMBO chargers**



Source: ABB, GH Electrotermia and EVTEC

In the COMBO standard, the communication between the electric vehicle and the charger is done using a different protocol than CHAdeMO. This communication

<sup>6</sup> <http://ccs-map.eu/>

protocol is called HomePlug Green Phy, based on a Power Line Communication (PLC) system. This technology uses the power lines for the high-speed transmission of data. The international standard that regulates this kind of communication is the IEEE 1901 and its application to the EVSE is addressed in the IEC 15118 series of standards.

Similarly to CHAdeMO, international efforts have been made to ensure the interoperability of the CCS quick charging systems (hardware & software) and the vehicles adapted to this standard. An initiative in this sense was led by the German and US Automotive Industry, with the participation of the Joint Research Centre (JRC) of the European Commission:

Figure 15: Scope of E-Mobility project

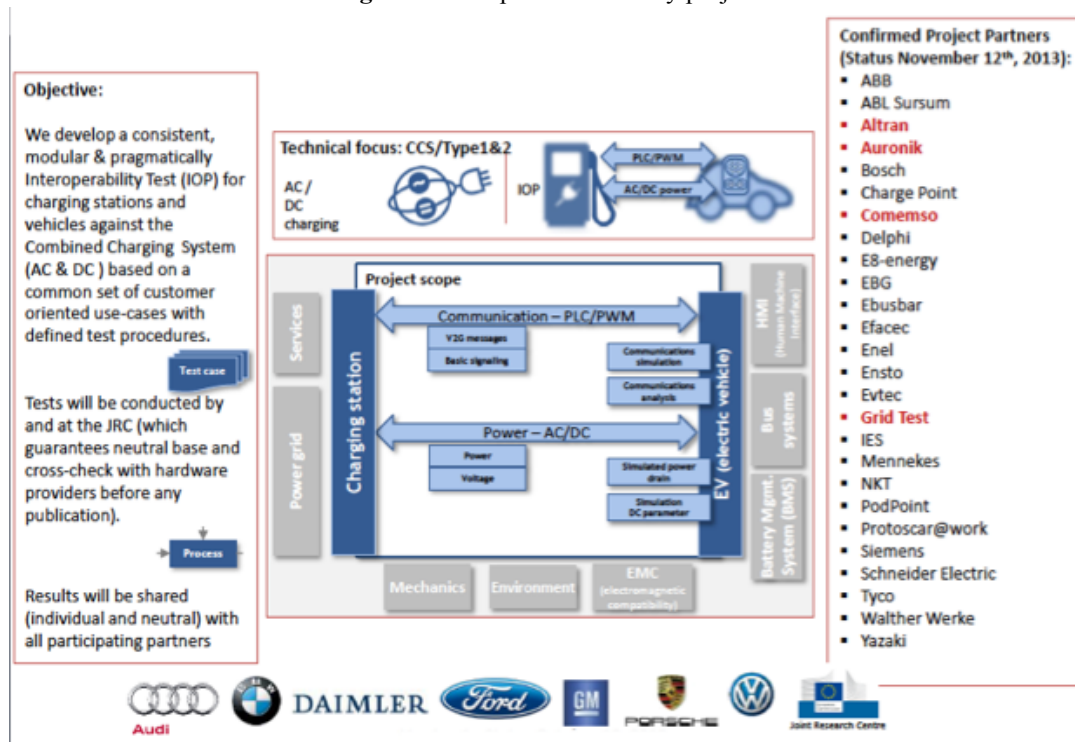

Source: Partners of the project

Nevertheless, there exist certain limitations to conventional quick charging tests programmes. Most of them are imposed by the proper use of the EV for the test banks, such as long time between charges, poor management of battery lifecycle, restrictions in the charge profile and duration (fixed charge curve), the need of several vehicles for continuous tests, impossibility to generate extreme charge situations to check quick chargers response, etc.

A proven solution for this is the use of an emulator. The research centre CIRCE, in Spain, has designed, developed and successfully used an electric vehicle emulator for testing the performance of quick chargers under difference circumstances. This equipment solves all the inconveniences listed above, accurately emulating any battery curve, the test can be performed under extreme conditions and problems that may occur during a charging process can be emulated.

### 2.3. CHAdeMO versus COMBO

The following table shows and compares the main characteristics of both industrial standards for quick charging:

**Table 7: CHAdeMO vs COMBO**

	CHAdeMO	COMBO	
<b>DC</b>			
Maximum Voltage (V)	500 V	600 V	850 V
Maximum Current (A)	120 A	150 A	200 A
Connector	CHAdeMO	Combo 1 (IEC 62196-3/ SAE J1772)	Combo 2 (IEC 62196-3)
Charging mode	4	4	
Max power (kW)	50 <sup>7</sup> kW	90 kW	170 kW
<b>AC</b>			
Nominal Voltage (V)	-	250 V	400 V (III-phase) 230 V (I-phase)
Nominal Current (A)	-	32 A	63 A (III-phase) 70 A (I-phase)
Connector	-	Type 1 (SAE J1772/IEC 62196-2)	Type 2 (IEC 62196-2)
Charging mode	-	3	3
Max power (kW)	-	13 kW	44 kW
Communications protocol	CHAdeMO	HomePlug Green Phy	

Source: CHAdeMO and CCS specifications

When the COMBO standard was developed, some vehicle manufacturers that had adapted their cars to the CHAdeMO standard feared that they had to develop new lines of vehicles prepared for the new standard, specially in Europe. However, very soon it was clear that the coexistence of both standards was possible, even though CHAdeMO is stronger in Japan and COMBO is expected to be dominant in Europe. The reason behind this is that a high percentage of the installation costs (90%-95%) are common to both standards, so there is not a big price difference between installing single-standard charging spots and dual-standard ones.

In September 2013, the company NRG eVgo installed the first dual-standard charging station in the United States and since then many others have followed. European charger manufacturers started to offer dual- and triple-arm chargers in 2013 (with a relatively low increase of the total cost). Moreover, retrofitting of the existing QC

<sup>7</sup> Most of the chargers available in the market have a maximum power limited to 50 kW, although the connectors and cables allow a higher output power

points (additional cost of between € 2,000 and € 3,000) offers a new solution to integrate Combo into existing CHAdeMO systems for low-cost infrastructure upgrade. Indeed, most of the new CCS charging points installed in Europe are actually dual-standard equipment and there are now many manufacturers worldwide that developed this type of chargers. Some examples are shown below:

**Figure 16:** Multi-system chargers



Source: ABB, ACT, GH Electrotermia and Circontrol

The rapid deployment of multi-system chargers in Europe, but also in North America, will change the framework of the competition among OEM's, removing the issue of connection standards and focusing it on vehicle models.

#### 2.4. Other quick charging technologies: inductive charging

Other technology that may be considered quick (taking into account the high output power that they can transfer) and that has received great attention by the sector stakeholders is inductive charging<sup>8</sup>. Indeed, the participants of the survey<sup>9</sup> consider that induction charge would be a solution almost as good as plug-in battery recharge on equal conditions, and some stakeholders envisage the uptake of this technology from the year 2018.

This technology applies the principle of electromagnetic induction to power vehicles using inductive power transfer. The system is based on an induction coil installed under the road and charged with a high-frequency AC that creates a magnetic field that induces a voltage in a vehicle-side inductive power receiver (pick-up), thus charging and powering the vehicle<sup>10</sup>.

<sup>8</sup> Power transfer levels of typical systems vary from 0.5 W to 50 kW with air gaps of 1-250 mm

<sup>9</sup> See graph A7 in Annex 1

<sup>10</sup> FABRIC project: <http://www.fabric-project.eu/>

**Figure 17:** Block diagram of the inductive power transfer system

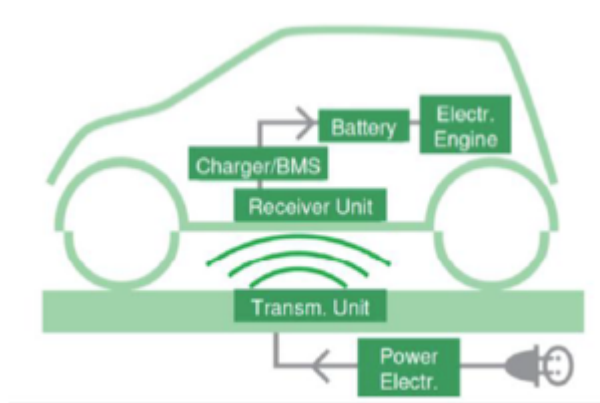

Source: UNPLUGGED project

Inductive charging is a relatively immature technology that will be ruled by the family of standards IEC/TS 61980<sup>11</sup>, all of which are still under development and not expected to be published before August 2015 (Part 1: General Requirements). However, its important advantages (specially en-route inductive charging) compared to conductive charging have been translated in a big number of research projects and initiatives to further develop this technology.

Three main inductive charging methods can be defined: stationary charging, static en-route charging and dynamic en-route charging<sup>12</sup>. On stationary charging, the car is parked on a charging point installed in a parking lot or in the street, for instance, and the wireless charging starts without additional effort. This offers several advantages over conductive charging methods: easy operation, safety against vandalism, reduced visual impact and, in general, very convenient for the user. However, the biggest benefits of this technology come from en-route inductive charging.

Static inductive en-route charging allows the vehicle to recharge its battery when standing still at the traffic lights, bus stops or taxi stands. Thanks to this technology, EVs will be able to charge during these short timeframes and extend the vehicle range. Furthermore, dynamic inductive en-route charging will allow charging the vehicle while actually driving it, providing the driver with virtually limitless range as long as he stays on paths specifically adapted for dynamic en-route charging. As an example of this, the project Victoria<sup>13</sup>, lead by Endesa in collaboration with CIRCE and others, has developed a wireless en-route charging for electric buses in the city of Malaga (Spain).

The main benefit of inductive charging will be the elimination of range anxiety, as conductive quick charging, but its widespread deployment could also lead to the reductions of the battery size of the car or the use of other storage equipment (such as

<sup>11</sup> See Annex 2 for more information

<sup>12</sup> UNPLUGGED project: <http://unplugged-project.eu/>

<sup>13</sup> <http://www.endesa.com/en/saladeprensa/noticias/wireless-en-route-charging-electric-buses>

supercapacitors), thus reducing the price of the EV, one of the main barriers to a massive market uptake for these cars.

However, and as mentioned before, inductive charging systems must overcome a series of technical barriers, such as lower efficiency (than conductive charging), slow power transfer rates<sup>14</sup>, safety issues and interoperability. All these problems become more challenging in en-route charging, in the presence of high misalignment.

In the regular meetings of Task 20, some of the collaborators have presented their work on this technology and the progress in overcoming these barriers; moreover, documentation on this research line has been provided. For instance, in the framework of the project UNPLUGGED<sup>15</sup>, a 50 kW inductive charger prototype<sup>16</sup> has been designed, deployed and tested, and activities aimed to analyse and design high-misalignment compensation topologies for ICPT Systems have also been conducted<sup>17</sup>.

A further study on the current state of this technology is being conducted by the sister IEA IA-HEV Task 26 on Wireless Power Transfer (WPT) for EVs<sup>18</sup>.

---

<sup>14</sup> Although 200 kW chargers have already been developed

<sup>15</sup> UNPLUGGED Project: <http://unplugged-project.eu/>

<sup>16</sup> J.L. Villa, J.F.Sanz, J. Sallán, “*Development of a 50 kW inductive electric battery charge system*”, EVS27, November 2013

<sup>17</sup> J.I. Villa, J. Sallán, S. Sanz, A. Llomabr, “*High-misalignment tolerant compensation topology for ICPT systems*”, III Transactions on Industrial Electronics, Vol. 59. No.2, February 2012

<sup>18</sup> <http://www.ieahev.org/tasks/wireless-power-transfer-task-26/>

### 3. Impact of the quick charging on the electrical grid

Despite the important role that quick charging has in the widespread deployment of electric vehicles, this technology poses a challenge in regards to its impact on the electricity grid. These problems are basically two:

1. The deterioration of the quality of the grid the charger is connected to.
2. The overload of the grid.

Both challenges increase significantly when the charger is connected to saturated and/or weak grids.

#### 3.1. Impact on grid quality

The problems on the quality of the grid are conditioned by the configuration of the power electronics embedded in the chargers (responsible of the AC to DC conversion in the conditions – voltage and current – requested by the EV). The most common PE configurations on the fast chargers available in the market are:

- 1) AC/DC converter based on diodes or thyristors;
- 2) AC/DC converter based on a Voltage Source Inverter (VSI);
- 3) AC/DC matrix converter.

The impact that they produce over the distribution grid may affect parameters such as the power factor, identified in the survey as the main concerned by the stakeholders<sup>19</sup>, and quality of the grid, meaning the introduction of undesirable voltage and current harmonics, flicker, voltage and frequency variations, etc.

Nevertheless, there has been an important work<sup>20 21</sup> on developing advanced PE to reduce the impact of the charger in the grid and nowadays almost all the chargers available in the market comply with the limits of power quality establish in the standard (IEC 61000-3-12) when charging at nominal power. In any case, DC quick charging produces proportionally less quality distortion to the electrical grid than slow and medium AC charging.

This is shown in the figure below:

---

<sup>19</sup> See graph A12 in Annex 1

<sup>20</sup> S. Dusmez, A. Cook, A. Khaligh, “*Comprehensive Analysis of High Quality Power Converters for Level 3 Off-board Chargers*”, IEEE, 2011

<sup>21</sup> T. Tanaka, T. Sekiya, H. Tanaka, E. Hiraki, M. Okamoto, “*Smart Charger for Electric Vehicles with Power Quality Compensator on Single-Phase Three-Wire Distribution Feeders*”, IEEE, 2012



**Figure 18: THDi DC/ THDi AC**

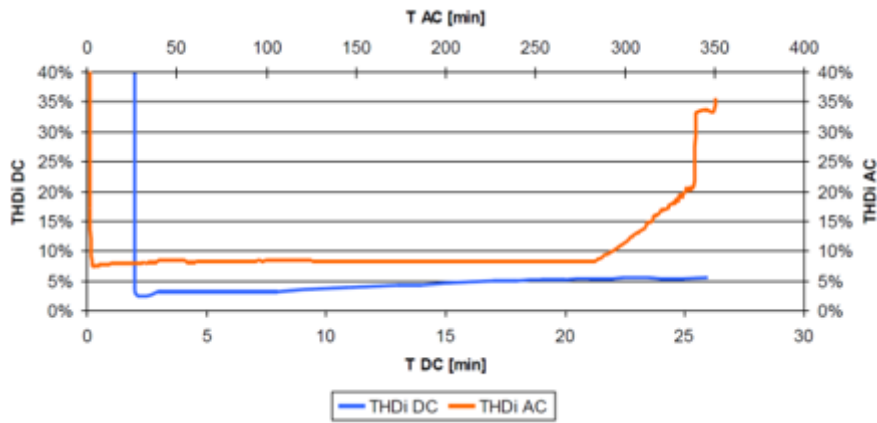

Source: CRAVE Project<sup>22</sup>

### 3.2. Grid overload

As mentioned before, the other main problem that quick chargers pose in regards to the electrical grid is its high consumption of energy in a very brief slot of time that may overload the grid. The following figure shows the power consumed by DC CHAdeMO charger during a normal recharge:

**Figure 19: Power consumed by a CHAdeMO charger for a recharging time of 20 minutes**

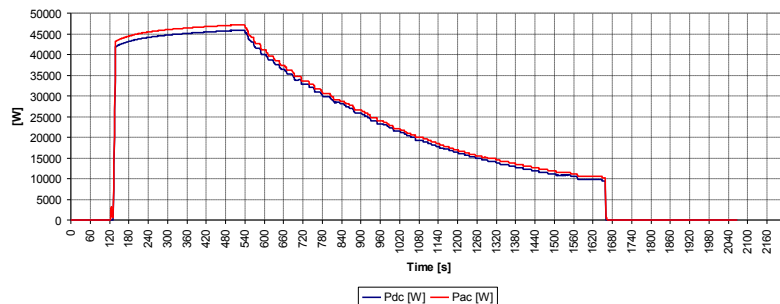

Source: CRAVE project

As an example of the significant load the quick charging may mean in the future, the charging of 20 million electric vehicles through slow charging technology would increase the power demand of the grid in 33,000 MW; the same amount of vehicles recharged using quick charging technologies would mean 80,000 MW<sup>23</sup>.

Many countries have today enough generation capacity to support the load that a large deployment of electric vehicles will mean. Recent studies carried out by the US Department of Energy have concluded that the grid in that country has enough excess capacity to support around 150 million of electric vehicles<sup>24</sup>. However, since the charging of the vehicles is not evenly distributed throughout the grid and along the day,

<sup>22</sup> Project led by CIRCE with the financial support of Endesa. More information in the following link: <http://www.fcirce.es/web/data/project.aspx?source=allprojects&id=73368>

<sup>23</sup> European Topic Centre on Air and Climate Change, “Environmental impacts and impact on the electricity market of a large scale introduction of electric cars in Europe” (2009)

<sup>24</sup> <http://data.worldbank.org/indicator/IS.VEH.PCAR.P3>.

the grid is not equally strong in all the country and power requirement from the EVs might increase in the future, the EV charging (and particularly QC) place a serious challenge to the grid.

This issue is particularly relevant since according to several studies, quick charges occur most frequently in the evening, often coinciding with grid peak demand. This phenomena is shown in the following figures:

**Figure 20:** Time of the day that vehicle trips start

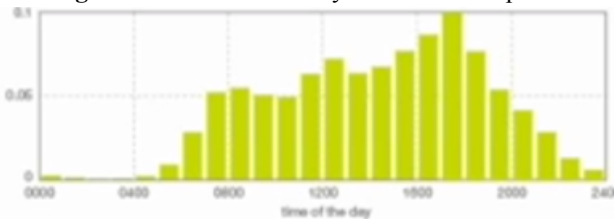

Source: Green Lots

**Figure 21:** Time of the day when quick charges occurs

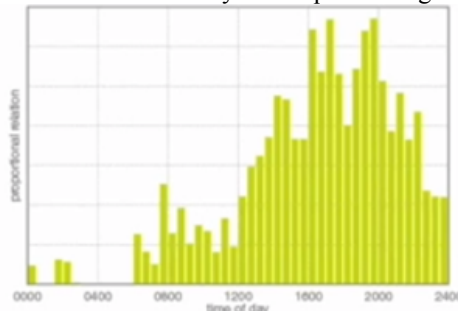

Source: Green Lots

### 3.3. Solutions to reduce the impact of quick charging to the grid

#### Energy Storage Systems

A solution to the overload problem is the connection of the quick chargers to smart grids along with demand control systems, energy storage systems (normally batteries) and energy generation based on renewables (Wind, PV). Through the management of the demand and the use of energy storage systems, the consumption of the charging point may be modified, thus reducing the consumption from the grid in the peak hours and increasing it on the valley hours.

The energy is stored in batteries during the night, when the load on the electrical grid is lower and then this energy is used during the peak hours to reduce the impact of the recharging process in the grid. This solution also means economic benefits, since the electricity is stored during the night, when the price is cheaper, and used it to recharge the vehicle during the peak hours, when the electricity is more expensive. This is the basis of intelligent charging.

The solution is shown in the figures below. An example of an electricity consumption profile is presented in blue and the extra load that EV quick charging means in green, coinciding with the peak hours. In figure 23, part of the electricity consumed by the EV

is swift to a time with much lower general consumption (valley hours) thanks to the use of energy storage systems, thus reducing the impact QC has into the grid.

**Figure 22:** Example of EV Quick charging impact during grid peak demand

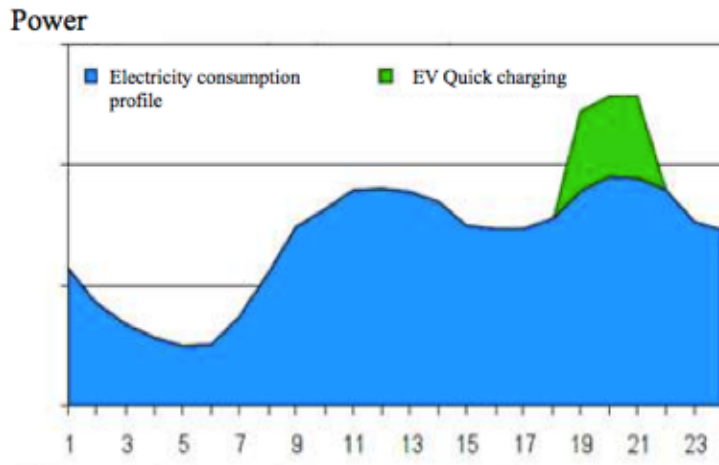

Source: CIRCE

**Figure 23:** Reduction of the EV QC on the electrical grid using energy storage systems

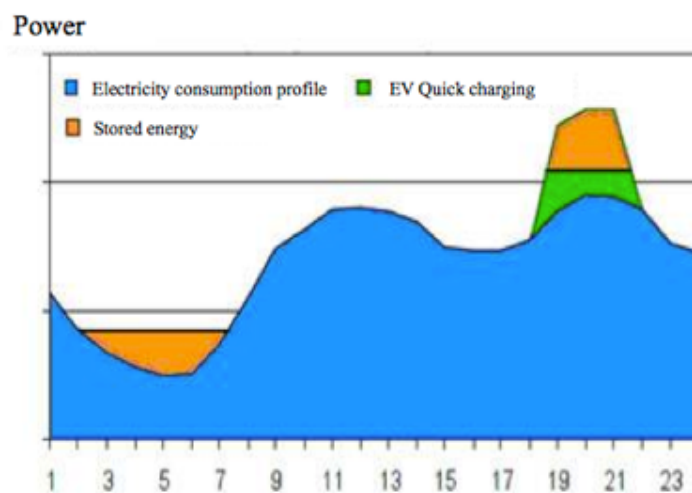

Source: CIRCE

This solution (either using second-life batteries or not) has a wide support from the stakeholders as the most promising to decrease the impact of QC on the grid<sup>25</sup>, along with remote management of the charger (still in an early stage of development<sup>26</sup>).

However, the integration of this equipment in the charger significantly increases the final cost of the electricity used for charging purposes according to the participants of the survey (particularly among the charger manufacturers)<sup>27</sup>. In this sense, the use of the

<sup>25</sup> See graph A10 in Annex 1

<sup>26</sup> See graph A15 in Annex 1

<sup>27</sup> See graph A11 in Annex 1

so-called second-life batteries (former vehicle batteries that have partially lost their capacity and are no longer suitable for their primary use) instead of the lithium ion stationary batteries would reduce the cost of the storage system.

Some of the collaborators of the task have conducted important research studies on this topic, using the second life batteries or other energy storage technologies, Lithium-ion battery packs being the most commonly used, for peak shaving<sup>28</sup> and reactive power compensation (using for this the power electronic converters in the battery system or in the charger).

This is shown in figure 25: the green line represents the power the charging process needs and that would have normally been absorbed from the grid. The use of the storage system (red line) allows reducing the demand from the grid in the first minutes of the process (in around 10 kW), thus limiting the impact of quick charging to the electric grid.

**Figure 25:** Peak shaving of the power absorbed from the grid by the quick charger using energy storage systems

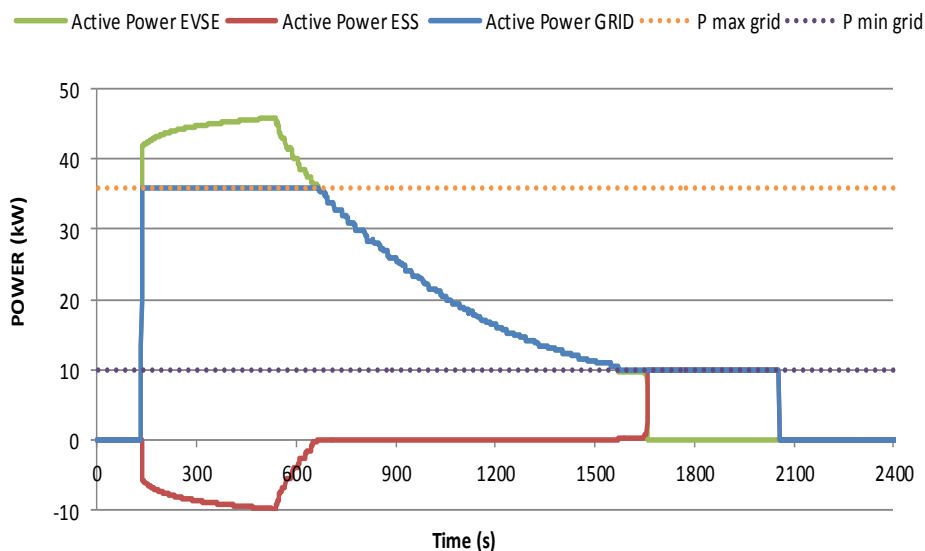

Source: Green eMotion Project

### Remote management

Another option to reduce the impact is the smooth use of remote management of the charging process. Stakeholders consider that this approach will reduce the impact of the QC mainly by limiting the power of the charger<sup>29</sup> and by controlling the charge process (e.g. relying on the grid, it would be suitable to send an external order to the charger to establish the maximum charge rate)<sup>30</sup>. For this approach, the needs and orders of the

<sup>29</sup> However, when limiting the power supplied by the charger, this does not operate in its optimal way, which could result in a higher impact on the quality of the grid. Furthermore, the duration of the charging process is extended.

<sup>30</sup> See graph A13 in Annex 1

distribution system operators to ensure the stability of the power system should be prioritize over those from other stakeholders, such as the Transmission System Operator (TSO), the charger operator, the owner of the charger and the retailer<sup>31</sup>.

### Renewable Energies

Furthermore, the integration of renewable energy generation with DC quick chargers may also reduce the energy consumed from the electrical grid, thus reducing the impact of the EV charging<sup>32</sup>.

**Figure 24:** Mitsubishi Motors North America, Cypress, CA: Level 1, 2 and DC Quick charge under Mitsubishi Electric Solar Panels



Source: Mitsubishi Motors North America

The topic of coupling renewable energy sources (RES) with electric vehicle charging using an Energy Management System (EMS) has drawn much attention, as way of mitigating the potential security issues on electrical grid that a large share of RES in energy mixes and large deployment of EV may cause, particularly to local congestions and voltage deviations. An interesting study of the possibilities of this option, considering the specificities of the local RES available has been conducted in France<sup>33</sup>, revealing the advantages of using an EMS for controlling EV charging periods, especially in those regions with high seasonal dependencies (PV production, for instance).

### Power Electronics

Much work has been done to investigate operation strategies to ensure voltage stability of the grid, particularly when the EVSE is connected to long lines far from local substations in low-voltage networks<sup>34</sup>. This connection is often not permitted by the

<sup>31</sup> See graph A14 in Annex 1

<sup>32</sup> R. Freire, J. Delgado, J.M. Santos and A.T. de Almeida, “Integration of Renewable Energy Generation with EV Charging Strategies to Optimize Grid Load Balancing”, Annual Conference on Intelligent Transportation Systems, 2010

<sup>33</sup> P. Codani, P-L. Le Portz, P. Claverie, Y. Perez, M. Petit, “Coupling local renewable energy production with electric vehicle charging: a survey of the French case”, EVS28, May 2015

<sup>34</sup> P. Krasselt, J. Boble, M. r. Suriyah, T. Leibfried, “DC-Electric Vehicle Supply Equipment Operation Strategies for Enhanced Utility Grid Voltage Stability”, EVS28, May 2015

DSO. However, EVSE equipped with active rectifiers allow reactive power voltage support, thus simplifying grid access. Other strategies based on voltage-amplitude regulated power factor control and voltage-droop control of reactive power have been analysed and proposed as suitable.

### Demand control

Furthermore, other collaborators have reported experiences in drivers' behavioural change as a solution to the aforementioned challenges. Data gathering and analytical intelligence are the basis to forecast and control the demand from EV charging, thus shifting the demand to times of the day that are more convenient to energy system.

However, modifying the EV driver behaviour is complicated and requires innovative communication and incentive programmes (rewards) to motivate positive behaviours. These strategies are not exclusively designed for reducing the impact of quick charging on the electrical grid, but they take into account all the possible charging options available for the EV drivers in the country or region.

An experience<sup>35</sup> in this line has been carried out by Mitsubishi Heavy Industries as part of a 12 million dollars project through the set up of an Electric Vehicle Charging Management Centre (EVC). The EVC collects data from around 100 EVs connected to a 3G network on their location and their battery level (among others), in order to forecast power demand for battery charging. From this data and analysis, the EVC contacts the EV drivers (through email or text) to indicate them how to proceed: either discouraging them from charging their batteries at that moment or encouraging them to charge at a certain location at a specific time slot. If the drivers follow the instructions sent by the EVC, they are given shopping points as a reward.

This project has been running since the winter of 2012 and Mitsubishi Heavy Industries is highly satisfied with the conformance rates shown so far by the participants of the project. As a concrete result, a recharging volume reduction of approximately 12% was achieved in the summer of 2013 during a three-hour peak demand period.

A similar solution has been developed within the initiative Smart City Malaga<sup>36</sup> under the project ZEM2ALL<sup>37</sup>, led by Endesa. In this case, the EVs had a smart recharging station connected to a Control Centre, from which energy usage can be managed and users are able to see, among other things, their energy consumption and how much carbon emissions they are saving.

The OEM BMW has also conducted a project related to developing new communication strategies to deliver real-time, dynamic data to the EV drivers using their Smart Phones, thus empowering them to make the best decisions concerning battery recharging<sup>38</sup>.

---

<sup>35</sup> EV City Casebook – 50 Big Ideas, Oct 2014

<sup>36</sup> <http://www.smartcitymalaga.es/>

<sup>37</sup> <http://www.zem2all.com/en/>

<sup>38</sup> EV City Casebook – 50 Big Ideas, Oct 2014

The company launched this pilot project in North America to accompany the introduction of their models BMW i3 and i8 on that market. The project consists on a smart charging app that provides the EV driver with real-time information concerning the options to charging the vehicle: when, where and how much it will cost. The data provided helps the driver to decide when to charge the vehicle in order to profit from the lowest rates.

**Figure 26:** Interface of the BMW Smart Charging App



Source: EV City Casebook – 50 Big Ideas, Oct 2014

Moreover, the app also displays a graph of the evolution of the electricity prices, allowing the drivers to design a daily and, even a weekly, battery charging strategy. This is possible due to the fact that the system is connected to the US national energy rate database. BMW claims that thanks to this app the BMW EV drivers will be able to save up to 400\$ per year. The app has been only available for the participants of the pilot programme so far, but it is expected to be released to the public in the year 2015.

The benefit of these strategies is, of course, not only money saving for the EV owners, but, as explain before, move towards a smarter charging scenario, thus shaving peaks and reducing the overload risks for the utilities.

## 4. Impact of the quick charging on the battery

Battery cost still remains as one of the main barriers to be overcome for a widespread deployment of the EV. Rechargeable batteries are usually the most expensive component of the vehicle, often representing half of the retail cost of the car. Despite the fact that the prices of electric vehicle have been constantly reducing during the last years (35% since 2008<sup>39</sup>) and are expected to continue falling in the future, there is an important concern among the OEMs regarding the possibility that quick charging may damage or degrade the batteries.

**Figure 27:** Estimated Costs of EV Batteries through 2020<sup>40</sup>

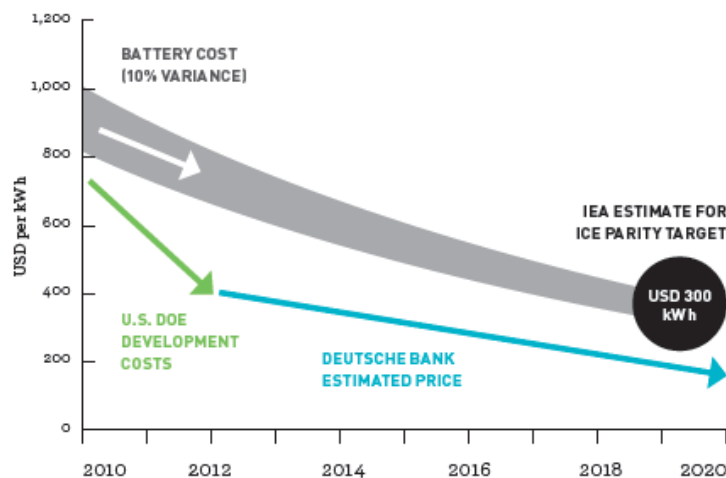

Source: IEA, US DOE, Deutsche Bank

Preliminary studies carried out by some of the collaborators of the Task show that the batteries do not actually suffer more wear when charged with QC technologies than batteries using other charging systems that endure lower voltage rates or longer charging cycles.

Idaho National Laboratory (INL) staff members have analyzed data from a group of 4 EVs (Nissan Leaf), 2 of which were only charged at “normal rates” (Level 2, or a maximum of approximately C/4) and 2 were only charged using modern quick chargers<sup>41</sup>. The vehicles were new and have been tested for identical on-road routes up to 50,000 miles over a year in Phoenix (Arizona), testing the battery performance every 10,000 miles. Significant battery degradation was observed in all test samples, but the difference between the two groups was relatively small, as shown in the figures below:

<sup>39</sup> "Vehicles - Department of Energy ". US Department of Energy. Retrieved 2014-05-03

<sup>40</sup> Global EV Outlook – Understanding the EV Landscape to 2020, Apr 2013

<sup>41</sup> Jim Francfort, “IEA IA-HEV: DC Fast Charger Use, Fees, Battery Impacts and Temperature Impacts on Charge Rates”, Idaho National Laboratory, September 2014. More info: <http://avt.inl.gov/fsev.shtml>



**Figure 28:** Evolution of the capacity of the battery for the 4 Nissan Leafs

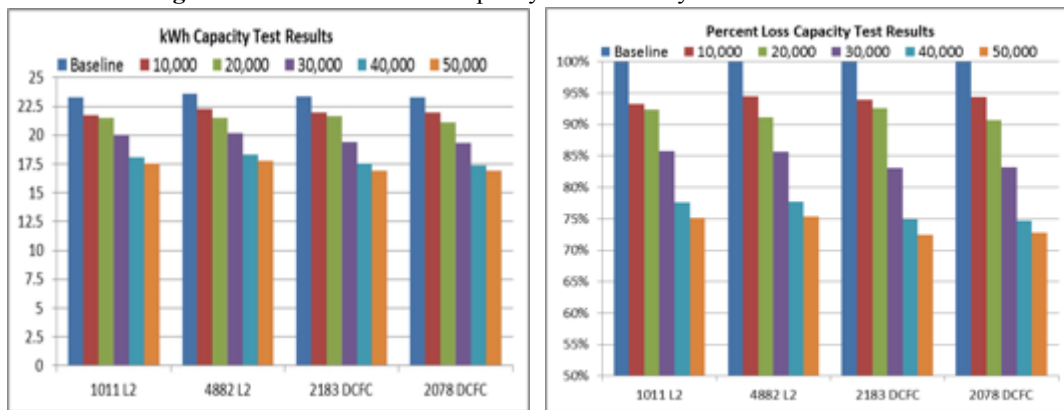

Source: Idaho National Laboratory

In the graphics, the first two columns (identified by codes 1011 L2 and 4882 L2) represent the performance of the EVs charged at normal rates (Level 2), whereas the last two columns (identified by codes 2183 DCFC and 2078 DCFC) represent the performance of the EVs charged using only quick chargers. The different colors indicate the batteries capacity and percent loss every 10,000 miles.

As mentioned, the results show an average capacity difference of 0.6 KWh (2.6% SOC) after 50,000 miles between the vehicles charged using normal and quick rates, which is not very significant. On the other hand, accelerated degradation could be correlated with other parameters such as elevated operating temperatures. Indeed, the data collected by the INL on the battery pack temperature during charging events, influenced by the ambience temperature, shows that the largest decreases in batteries capacity occurred during high heat charging operation (for the 20-30 and 30-40k miles, coinciding with the summer months):

**Figure 29:** Battery pack average temperatures and evolution of the % capacity loss for the four Nissan Leafs

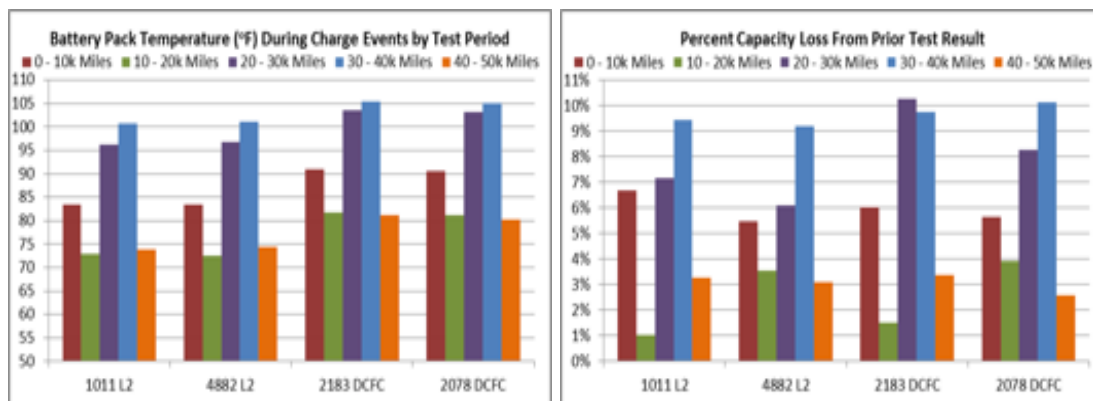

Source: Idaho National Laboratory

In the same line, studies by the National Renewable Energy Laboratory (NREL) that combined vehicle data and simulation calculations indicate that moderate use of quick charging, up to 10 times per month for 10 years, does not seem to accelerate the rate of

battery degradation significantly relative to Level 2 charging (AC slow charging)<sup>42</sup>. In moderate climates (e.g. Seattle), the type of battery temperature management system does not have any significant effect on the rate of degradation. This is shown in the figures below for two types of battery thermal management systems: passive cooling and high-power liquid cooling.

**Figure 30:** Battery pack average temperatures and % capacity loss after 10 years in moderate climates

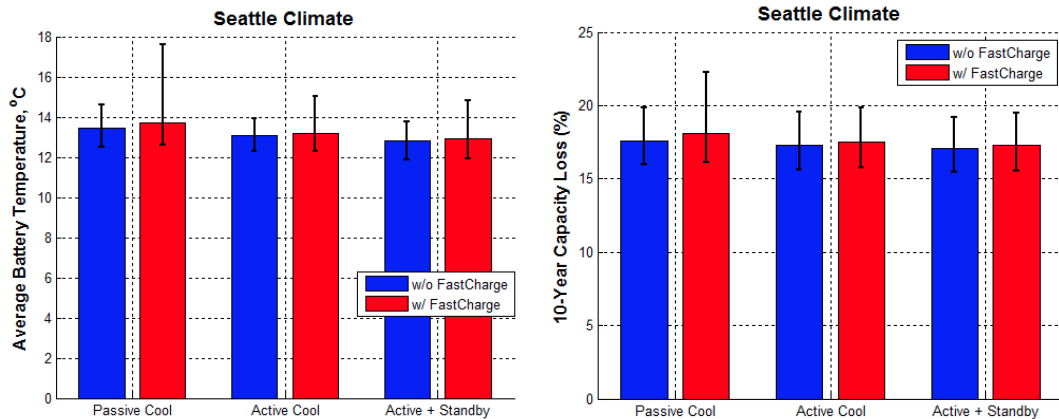

Source: National Renewable Energy Laboratory

In hot climates (Phoenix), active cooling offers significant benefits relative to passive cooling. Batteries being charged with a high ambient temperature and only passive cooling can reach undesirably high temperatures. If these batteries are quick charged under these conditions, temperatures may reach very undesirable levels. The figures below show the average battery temperature for a charging event in Phoenix with three different types of Battery Management Systems (left) and the degradation the battery suffers after 10 years of charging following the same pattern when charging using only slow charging and when combining with quick charging (right).

**Figure 31:** Battery pack average temperatures and % capacity loss after 10 years in extreme climates

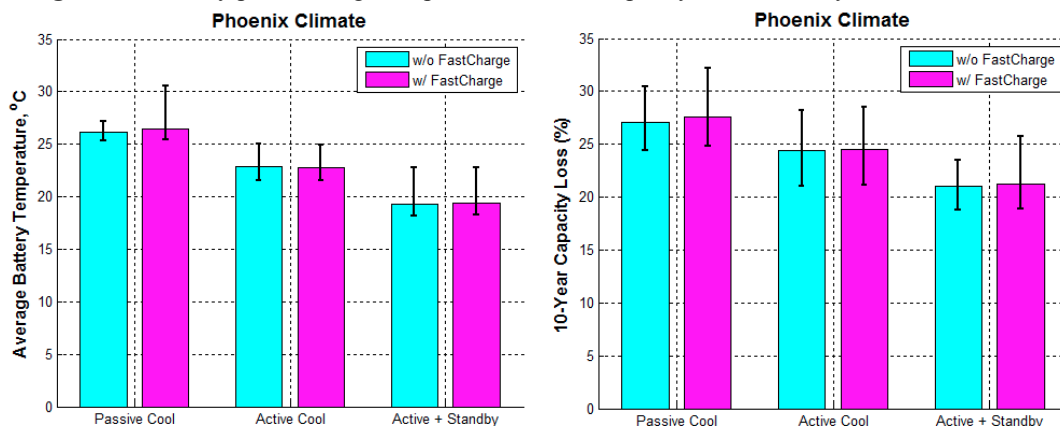

Source: National Renewable Energy Laboratory

<sup>42</sup> Jeremy Neubauer, Eric Wood, Evan Burton, “Fast Charging Impact on Extending VTM and Battery”, National Renewable Energy Laboratory, September 2014

Both cases (Seattle and Phoenix) show that there is very little difference on the battery capacity loss (%) when using only slow charging and when combining both charging modes, in line with the conclusions of the study carried out by the INL. What does significantly affect the degradation of the battery is the operating temperature, which is related with the BMS in use.

On the other hand, quick charging of a lithium-ion battery at low temperatures can lead to lithium plating onto the negative electrode. This plating can result in degraded performance and potential safety issues. To avoid such degradation, quick chargers and the vehicle control systems normally limit the rate of charging at extreme temperatures.

Complementing the issue of the degradation of the batteries, another issue that has attracted considerable attention is the potentially lower charging efficiency of quick charging as a result of chemical and Joule losses. This would mean an increase of the energy consumption for charging the EV and its associated increase in cost. There are some studies on this matter, comparing the battery, charging and overall efficiency for different types of charging, AC (four different output power) and DC, and for different battery SOC initial states. First results<sup>43</sup> have shown the dependency of charger and battery efficiency on charging power and on the battery SOC initial state, but the efficiency of the charging process is not lower for DC quick charging than for AC charging. These preliminary results are shown in the table below:

**Table 8:** Overall efficiency for different power and initial SOC values

	P [kW]	3	16	22	43	50
SOC	23	83	82	88	84	86
	43	83	86	88	83	84
	60	83	81	81	80	78

Source: A. Genovese, F. Ortenzi, C. Villante, “On the energy efficiency of quick DC vehicle battery charging”, EVS28, May 2015

Anyways, it has been made apparent that a BMS has to be worked on and that a charger should be designed that is sufficiently advanced as to “protect” the batteries and guarantee that they will work properly and suffer less wear.

To this end, battery management systems will need to be extremely precise and capable of detecting the battery’s condition. For instance, in hybrid quick-charging vehicles, batteries are never fully charged or discharged, which requires more advanced equipment, making them more complex and expensive.

In view of all these issues, the discussions during the lifetime of the Task clearly revealed that what the sector needs is a quick charging system where the chargers have the ideal power electronics and the battery management systems are run on sufficiently advanced communication protocols and structures. All these aspects are linked to price, which in turn affects the battery’s control and charger design. This poses an additional

<sup>43</sup> A. Genovese, F. Ortenzi, C. Villante, “On the energy efficiency of quick DC vehicle battery charging”, EVS28, May 2015

challenge when it comes to developing a business model for all those involved in using vehicles that are charged in this way, including vehicle and charger manufacturers, energy supply companies, manufacturers of ancillary equipment and the like.

Another issue is that manufacturers lack a standard to define essential features in terms of battery safety and performance, which is further aggravated by the vast variety of batteries on the market. In response, it has been argued that an international standard should be implemented to lay down the basic rules that are agreed on and proven effective in both aspects. This would establish a series of minimum parameters and thus provide both battery and vehicle manufacturers with the guarantees they need.

Lastly, it is of vital importance including battery design within the broader concept of mobility for the purpose of lessening costs and simplifying the business model. The fact is that battery performance is also affected by how the vehicles are used (i.e. by drivers), which means it is important to link their design to the specific use that will be made of them by consumers, a matter that varies by continent, country, social condition, availability of charging points, charge frequency and so on.







## 5. Business models for quick charging

One of the main concerns of the stakeholders is the business case for quick charging technology, which is needed to foster a larger deployment. All actors have concerns about the future model of a larger deployment of EV using quick charging as well as how to incorporate their equipment into real cases. The Task has fostered the exchange of information and points of view among stakeholders in order to better understand the whole picture and to identify the potential gaps and the best approaches from all involved entities related to quick charging technology.

Under this dialogue, as a main conclusion, it appears that there is no clear and unique business model solution. Several on-going projects and deployment activities are taking part across the globe with different approaches: some of them promoting the added value of using QC firstly among the costumers while in other demonstration cases, infrastructure and cars are at the front of the strategy plans. No matter how barriers (both technical and non-technical) are confronted, the full business plan will not be completed before investing and pushing the deployment forward. The model should be flexible and evaluated, adapted to prices and real needs in the hope of enlarging the network and customers.

It seems clear that the role of quick charging is supplementing “normal” charging, i.e. AC slow charging at home or at work (private infrastructures). Quick charging is then used in public infrastructures in urban areas (super markets, drug stores, shopping malls...) together with AC semi-quick charging (around 20 kW – charging mode 3) and, specially, for long distance inter-city drive, so EV drivers can charge using quick chargers installed along major roads and highway service areas (similar to current gas stations).

**Figure 32:** Potential mixture of charging methods

	Short Distance	Mid Distance	Long Distance
Length			
Charging type	Office charging 	Destination charging 	Pathway charging 
Charger type	Normal	Semi-fast or fast	Fast
Charging Site	Home/Office	Urban area (Super Market, Mall, Restaurant, Parking Lot or Gas station in city)	Inter city / National network (Service Area, Gas station)

Source: CHAdeMO

This consumer perception of the quick chargers as the mean to extend the range of a longer than usual journey is confirmed by a survey made by the Newcastle University:

**Figure 33: why drivers use quick charging?**

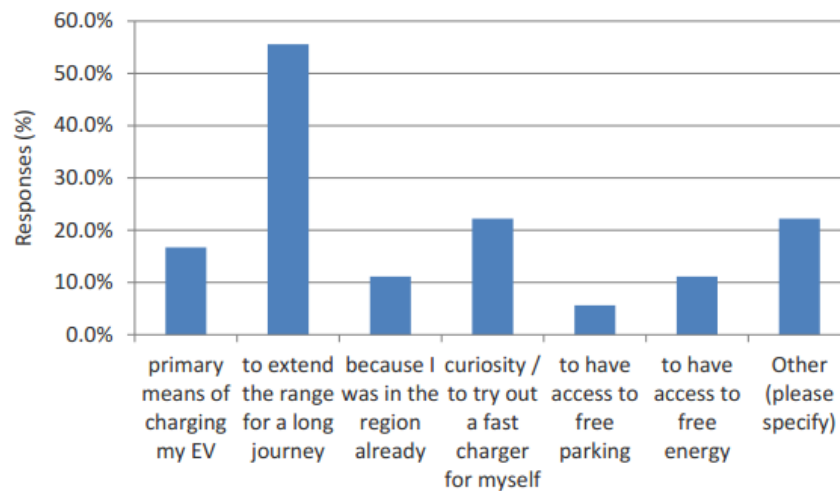

Source: Newcastle University

And it has also been empirically proven in Japan:

**Figure 34: quick charger as a range extender tool**

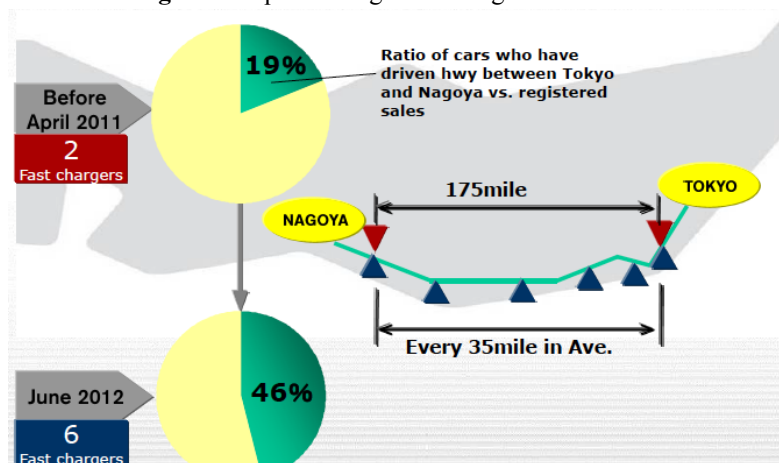

Source: Nissan Motor Co.

A better understanding of the customer behaviour and needs is precisely the starting point to defining the business model, as highlighted by the vast majority of the stakeholders that participated in the survey<sup>44</sup>, especially the private sector. Moreover, a continuous interaction and support to existing and potential new customers through information programmes, remote assistance, etc. has also been identified as highly important.

The Idaho National Laboratory (US) conducted a study on 2013 on the driving and charging behaviours and charge locations preference of the consumers. The project, collected data for 124 million miles of driving and 6 million charging events from more than 8,000 private vehicles (three models: Nissan Leaf, Chevrolet Volt and Smart EV) and an infrastructure composed by 12,500 charging points (including residential and

<sup>44</sup> See graph A1 in Annex 1

public level 2 EVSE as well as 107 DC quick chargers) in different urban areas of the country. The results showed that those drivers that had access to workplace charging used public infrastructure very rarely during the weekdays (2%) and rarely in the weekends (8%).

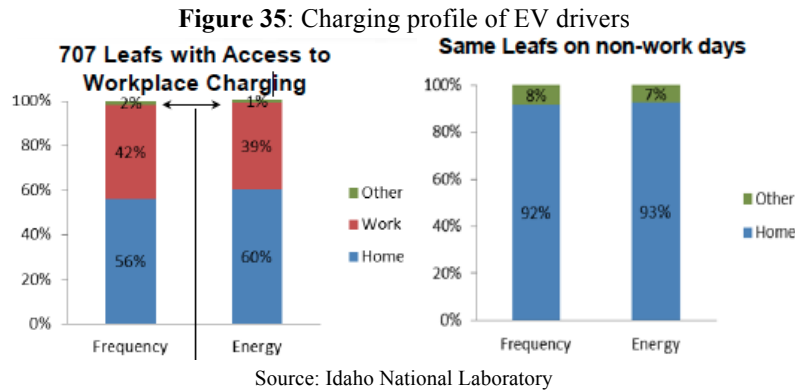

Other studies also support this low need for the drivers to charge outside home or work, as most of the journeys (93% of trips in Great Britain<sup>45</sup>) are well within a current EV battery range.

After one year, 2.2 Million charge events were recorded, of which only 3% were publicly accessible DC quick charging. This means 71,800 total DC charging events, which is an average of 2.3 charge events per day in each charging point. Taking into account the elevated costs of the chargers and their installation (average of \$21,000 for the infrastructure in the project), and also considering the utility demand and energy charges and other costs (maintenance costs, communication & authentication fees, insurance costs...), it is very difficult to build up a business model with no public support for DC QC, especially with such a low usage.

Specifically in what concerns to the utility demand and energy charges, stakeholders claim for a thorough review of the regulatory framework in order to move towards a more applicable electricity tariff structure, which is one of the hampering factors for developing a business case for QC, as mentioned before. The following table shows the significant demand charges per month that the utility imposes for serving a DC quick charger in different areas of four US states.

**Figure 36: Utility demand charges/month in different US states**

Utility Demand Charges - Nissan Leaf		Cost/mo.
CA	Glendale Water and Power	\$ 16.00
	Hercules Municipal Utility:	\$ 377.00
	Los Angeles Department of Water and Power	\$ 700.00
	Burbank Water and Power	\$ 1,052.00
	San Diego Gas and Electric	\$ 1,061.00
	Southern California Edison	\$ 1,460.00
AZ	TRICO Electric Cooperative	\$ 180.00
	The Salt River Project	\$ 210.50
	Arizona Public Service	\$ 483.75
OR	Pacificorp	\$ 213.00
WA	Seattle City Light	\$ 61.00

Source: Idaho National Laboratory

<sup>45</sup> DfT analysis

Indeed, demand charges can have a negative impact on per charge costs for quick charging, as shown in the example presented below, assuming a \$12/kW demand charge by the utility. For infrastructures with relatively low usage, the cost each EV user should pay to make the quick charger profitable would be very high (even though this example does not take into account installation, maintenance and operation costs).

**Table 9:** Composition of the energy costs depending on charging events/month

Scenario	Number of Vehicles Charged/ Month	Meter Charge	Demand Charge	Energy Charge	Monthly Total	Cost per Vehicle
1	0	\$200	\$0	\$0	\$200	N/A
2	1	\$200	\$600	\$2.20	\$802.20	\$802.20
3	10	\$200	\$600	\$22	\$822	\$82.20
4	100	\$200	\$600	\$220	\$1,020	\$10.20
5	250	\$200	\$600	\$550	\$1,350	\$5.40
6	500	\$200	\$600	\$1,100	\$1,900	\$3.80

Source: EV Project

Other issue that needs to be addressed when defining the business case is the optimal pricing of the service. At the beginning of the EV Project<sup>46</sup>, in which INL had a relevant role, there was no cost for using the quick chargers. The number of charging events grew steadily over several months as users learned the locations of the chargers and more vehicles were added to the project. When the company operating the charger network instituted a fee per charge (5\$/charge for members, 8\$ for non-members), the use of the chargers dropped significantly, as shown in the figure below, and eventually the company went out of business.

**Figure 37:** Evolution of the DC charging events/day

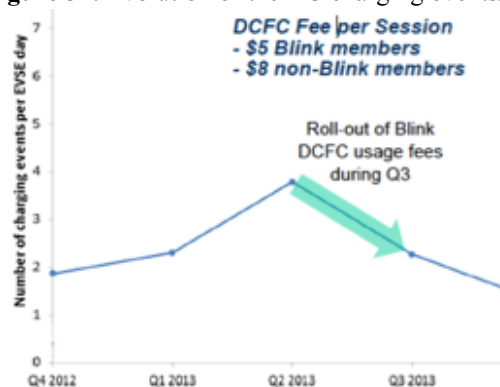

Source: Idaho National Laboratory

It is therefore encouraged to establish the system for grasping EV users behaviour /movement and profile of EV users to provide more convenient service in the initial stage after switching from free of charge to charge.

<sup>46</sup> <http://www.theevproject.com/>



Furthermore, the relatively high number of actors involved in the battery recharging process of EV creates a very complex ecosystem, with many different interests and several potential business models depending on who the owner of the EVSE is. There are many possibilities: an independent private service provider, a public foundation, a DSO, private business such as restaurants, retailers, etc.

The complexity of the aforementioned frame is illustrated in the figure below:

**Figure 38:** actors involved in the EV charging process

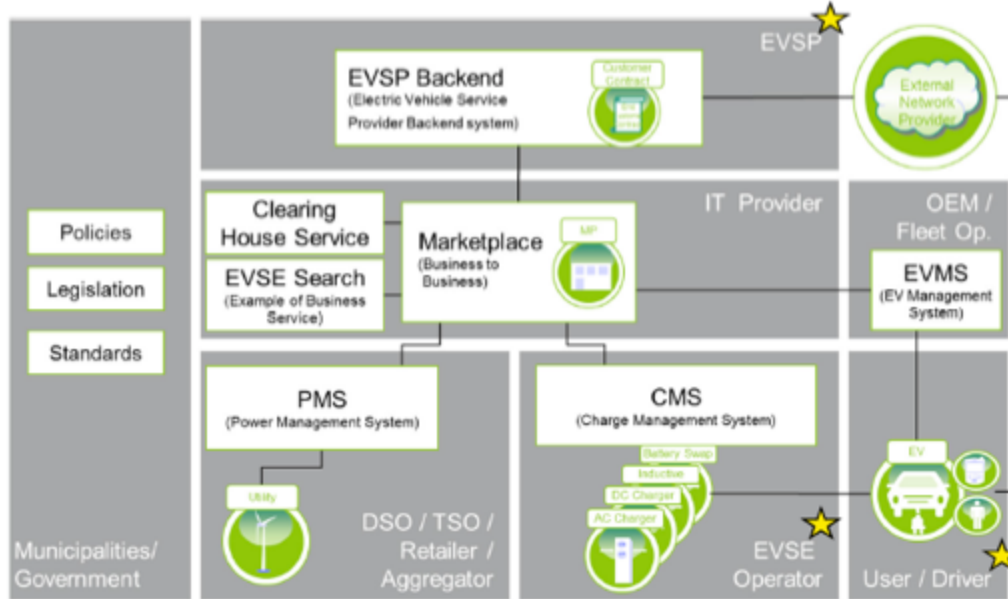

Source: Green eMotion project

### Possible options for a successful business case for QC

In order to overcome the aforementioned barriers, EV network alliances are needed to share costs and investment at the beginning. A strong coordination among the involved stakeholders is very fruitful for launching a smart business model, bearing in mind that quick-charging services alone cannot be economically viable. Stakeholders suggest the integration of additional services that the driver can use while recharging: different possibilities exist, being parking discounts (in urban areas) and discounts in nearby shops as the most promising ones<sup>47</sup>.

An important role for new technologies is also envisaged and the possibilities offered particularly by smart phones are very promising. Some options that are already in use are real-time information on location, availability and price of the QC infrastructures or identification/payment through the phone. Actually, the location of the infrastructures is seen as one of the main concerns of quick charger users<sup>48</sup> and indeed several mobile apps and websites have been developed lastly in order to cover this need.

<sup>47</sup> See graph A1 in Annex 1

<sup>48</sup> See graph A4 in Annex 1

It has been detected that most advanced deployment initiatives are based in the fact that owners install and operate quick-charging stations mostly due to non-economic reasons at the first stage (Japanese case), such as a series of public services, corporate social responsibility and contribution to environmental abatement. Nevertheless, it is invigorated to link business models and real motivation targets (stakeholders commitment in conjunction with the political support).

As stated before, the strong involvement of public authorities in the first stages of the deployment of the quick chargers is essential, according to stakeholders. Subsidies for the installation, maintenance and operation of the quick charging infrastructure are seen as the most important contribution by the public sector along with other incentives to be progressively decreased when the business model is in place<sup>49</sup>.

Table 10 sums up all the aforementioned considerations and present the different possibilities for a sustainable business model for public infrastructures, such as the main purpose of the chargers depending on their location, an indication of the envisaged cost per charging events and the need (or not) of public support in each case.

**Table 10:** Summary of the different possibilities for public infrastructure

Public Venue	Cost to EV Driver	Infrastructure Incentives	Subsidized Infrastructure
Retail	Low	Attract business	Yes
Municipal/ Public	Medium	Equity issues	Yes
Parking Structures/ Garages	High	Revenue based	No

Source: Aerovironment

As mentioned before, price is, of course, a major factor for customer engagement. The prices of energy (kW/h/\$) can affect and have an impact in the whole system and subsequently, a modification of the potential business case can occur, as seen before. Different pricing strategies can be adopted: pay-as-you-go, free service, flat rate monthly or annual subscriptions to a charging networks or a combination of several may be found nowadays.

In this initial stage, when the market of the EV is still small, the preferred method seems to be membership fees (although others have already been put in place), as the best option to sustain the infrastructure. Furthermore, membership fees would not only cover the price of the energy consumed but also the sense of security that quick charging stations offer to EV drivers, regardless their utilization rate, which is essential for a widespread deployment of electric vehicles. In medium to long-term, a more flexible payment method, usually by credit card or using the phone, is envisaged. The price could be established for charge, for minute or for kWh consumed.

Anyway, the cost of the charging services is considered to be more important for the

<sup>49</sup> See graph A2 in Annex 1

consumers than the way this payment is done. Concerning the identification of the user, this is currently done and it is expected to continue being done by phone or RFID card.

A practical example of pricing strategies can be found in Estonia, where the public foundation KredEx operates an extensive quick charging network covering all the country. EV users may choose between several pricing packages: (i) combined package: monthly fee of 10€ + 2,5€ per charge; (ii) flex package: pay-as-you-go with different prices, increasing with the duration of the charge; (iii) volume package: flat rate of 30€ up to 150kWh and pay per charge if the limit is exceeded. The driver must register first as a user of the network and then identify him/herself before charging, using an RFID-card, a mobile app or an SMS. The users are charged through monthly bill, similar to payment schemes for mobile phone carriers. A similar model is developed in Ireland, with an EVSE network deployed and operated by the same public company (ESB).

This model may work in a small country like Estonia, where there is only one network service provider, but it poses a challenge in places where EVSE operated by different organizations are deployed under free competence scenario: the EV users are then locked to only one service provider. Much work is on going to develop international standards on communication protocols to solve this situation and allow EV drivers to recharge their EV in any charger point, in a similar way as ATMs work. This is indeed one of the biggest barriers identified by the stakeholders for the development of a consistent business model for quick charging: interoperability and the need of creating standardized interfaces to make it possible the interaction of different equipment and communication systems<sup>50</sup>.

### Interoperability

A particularly relevant issue for the success of quick charging is interoperability, mentioned several times along this document and that deserved a dedicated Task meeting (Barcelona, 2013). Under this headline, a thorough description of the possible solutions to this issue discussed in that meeting is presented.

Participants in the Task 20 survey were asked about how different service providers could establish interoperability. According to them, the most urgent matters to work in are, as pointed out before, the standardization of payment methods and information and the standardization of the communication protocols (through open interfaces and protocols) and hardware between quick charger and EV service providers. A closer collaboration with utilities and sharing charging points management protocols are also identified as necessary<sup>51</sup>.

The following figure shows the different interfaces relevant to public charging and the challenge of interoperability:

---

<sup>50</sup> See graph A3 in Annex 1

<sup>51</sup> See graph A8 in Annex 1

**Figure 39: Key Interfaces for Public Charging**

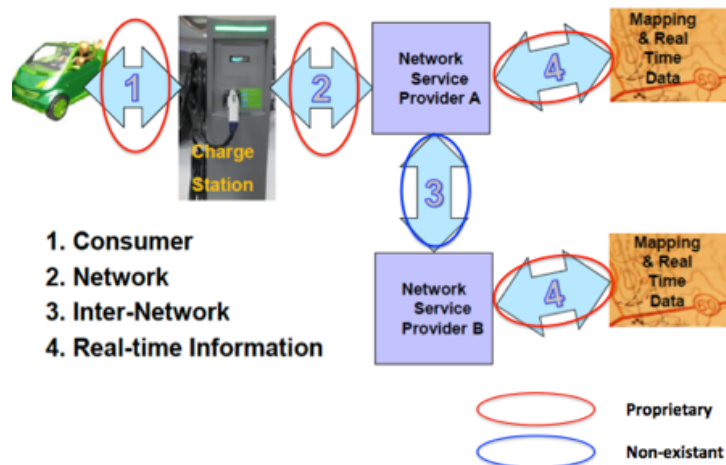

Source: Electric Power Research Institute (EPRI)

This situation leads to a scenario where all EVSE Networks are proprietary and there are no common links at any level. As mentioned before, this means a big barrier for the development of a successful business model for public charging (main form of QC), as consumers must belong to multiple networks, thus carrying multiple credentials, and EVSE operators are either locked to a particular network (with the associated risks that this means, such as bankruptcy of the network provider) or forced to support multiple proprietary network protocols.

Different solutions have been developed in the last years to overcome this problem, such as network clearing houses (like Collaboratev or Hubeject<sup>52</sup>) that bridge proprietary networks or standard backhauls (like Open Charge Point Protocol – OCPP<sup>53</sup>) addressing the EVSE to service provider link, so that EVSE operators may work with any network. These two solutions are represented in the figures below:

**Figure 40: Network clearing house (left) and standard backhaul (right) approaches**

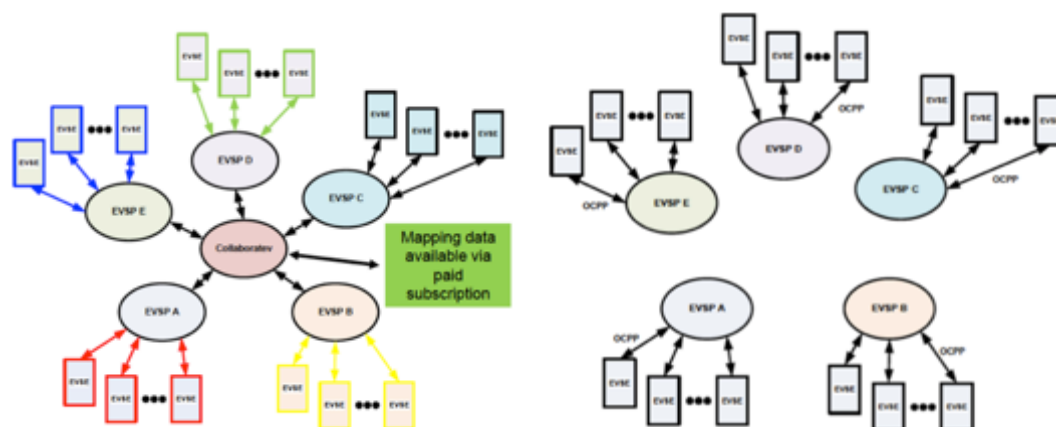

Source: Electric Power Research Institute (EPRI)

<sup>52</sup> <http://www.hubeject.com/>

<sup>53</sup> <http://www.openchargealliance.org/>

Both solutions present advantages and drawbacks. A standard backhaul enables EVSE operator to change networks without replacing hardware and prevents them from being stranded by a network provider going out of business but it does not address roaming across networks or common user credentials. A network clearing house does allow consumers to roam across networks but it means an additional cost that must be covered but someone and does not prevent EVSE to get stranded if a network provider fails. Therefore, a comprehensive solution (or complementary solutions) to the challenge of interoperability is still necessary, as highlighted by Task 20 participants in the meetings and survey.

## 6. Vehicle-to-grid (V2G)

In section 3, the potential impact that the electric vehicles have on the grid when charging (grid-to-vehicle – G2V), has been discussed. However, the batteries that power the EVs can also act as distributed storage units and potentially provide energy back to the grid if the required technology is deployed. This function is known as vehicle-to-grid (V2G). V2G technology allows the EV to act as a flexible and on-demand asset to enable more reliable, dynamic and efficient running of electricity services by providing the grid with balancing and regulation services. Thanks to the V2G concept supply and demand sides “get connected”, enabling improved efficiency and optimized energy supply with no waste or shortage.

Figure 41: V2X in the energy system

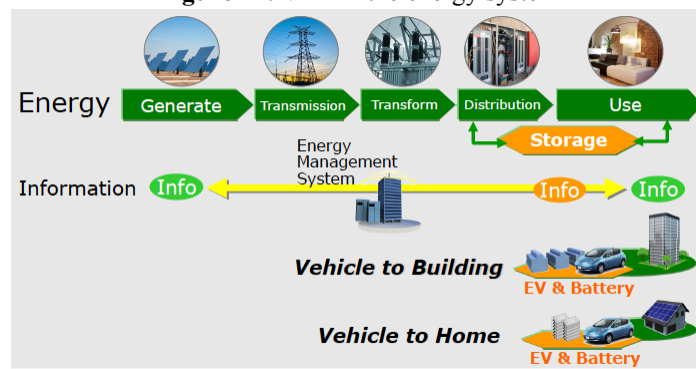

Source: Nissan

This option becomes more attractive when taking into account that the EVs are parked 95% of the time and that they often have a significant amount of power store when starting the charging process (most likely over 50% of the total charge capacity of the battery). The high potential of a fleet of EVs acting as distributed storage (and generation) units is shown in the figure below:

Figure 42: Energy Storage Capacity of EVs (Nissan LEAFs)

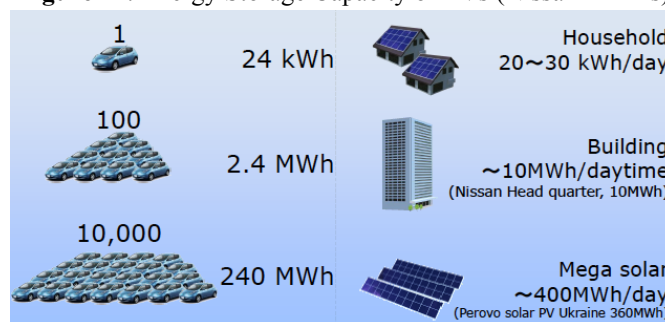

Source: Nissan

The concept of V2G is rather simple and, in theory, easy to implement: a household that combines an EV, PV panels and a smart meter would become an electricity provider and could generate revenues by selling electricity, either to the grid or to neighbouring houses. Moreover, V2G could have a large potential as a mean to provide ancillary

services. The roll out of V2G concept is highly conditioned on the national regulatory framework, as there are countries in which selling electricity back to the system is not regulated.

Naturally, V2G is only possible when both EVSE and EV are equipped with the required technology. This means basically software and a power control system that makes it possible to manage electricity in a bidirectional way, determining when the vehicle draws electricity from the grid and when it provides it back. Obviously, the V2G concept is very closely related with Smart Grid. Several pilots have been developed in order to demonstrate the viability and potential of this technology.

For instance, Nissan Iberia and Endesa are cooperating to develop a marketable V2G system in Europe<sup>54</sup>, using a bidirectional quick charger based on CHAdeMO standard developed by Endesa that could be activated from the charging point or remotely managed. The system will also integrate renewable energies not connected to the grid, such as PV panels or wind turbines.

V2G applications can be divided into three main categories: Vehicle-to-Home (V2H), Vehicle-to-Building (V2B) and Vehicle-to-Community (V2C). Japan is the only country where V2H systems have been widely deployed. Nissan launched its “LEAF to Home” V2H system in 2012 and, as of December 2014, some 2,400 V2H systems have been installed in the country. Table 11 shows the specifications of a “LEAF to Home” system made by Nichicon Corporation and figure 43 shows the scheme of the system:

**Table 11:** LEAF to Home specification

		Standard Model
Size (cable not included)	Main Unit	650(W)*780(H)*350(D)mm, 68kg
	Junction Box	710(W)*370(H)*150(D)mm, 10kg
Charging	Voltage & Current	Single phase with 2 lines, AC200V, up to 30A
	Power	Up to 6kW <sup>1)</sup>
Discharging	Voltage	Single phase with 3 lines, AC100V*2
	Current	Up to 30A (each phase)

Source: Nichicon Corporation

**Figure 43:** LEAF to Home scheme



Source: Nissan

Based on the current utilisation of the “LEAF to Home” system, Nissan conducted a study<sup>55</sup> of the actual and potential benefits that this system brings to its users. The study concluded that the V2H users<sup>56</sup> can expect now annual savings of approximately 30,000 JPY (around 222 euros) but it is expected that this savings rise to 40,000 JPY (296 euro) for V2H systems allowing optimum charging and discharging automatically, based on energy rates, renewable energy generation and EV automated usage. Other benefits of

<sup>54</sup> <https://www.esmartcity.es/noticias/endesa-y-nissan-se-unen-para-avanzar-en-infraestructuras-de-carga-v2g#>

<sup>55</sup> T. Nakada, T. Nakano, H. Akizuki, “Assessment of economic potential of Vehicle-to-Home (V2H) in Japan with customer driving habits taken into account”, EVS28, May 2015

<sup>56</sup> EV owners and residents of the house where the V2H system is applied

V2H aside the cost savings are the back-up power in case of emergency or the environmental contribution.

However, the future of V2G is still uncertain, regardless its potential and despite the fact that the technology is not an issue, but the knowledge about the economic, environmental and grid benefits is underdeveloped, inconsistent or not validate<sup>57</sup>. Indeed, most of the studies conducted on the matter are focused on technical aspects and, although researches have tried to assess the commercial potential of this technology, it is not clear yet how to capture this value and several business models have been proposed. As highlighted in the business models section for quick charging, in the particular case of V2G, preferences of the users must be the central point for deriving a business model.

An interesting study for assessing the consumer’s preference and defining a business model based on them was conducted in The Netherlands<sup>58</sup>. The researchers propose a business model with an emphasis on functional issues (ease of use, safety, reliability, sufficient range...) rather than financial issues provided by the utility company, also responsible of providing a supporting public charging network, and used by private owners of EVs with bidirectional chargers at home. The following table summarizes the characteristics of the V2G business model proposed by the authors:

**Table 12:** Derived V2G business model

Value proposition	Value network	Revenue model & cost model
<i>Based on factor analysis</i>	<i>Based on conjoint analysis</i>	<i>Based on conjoint analysis</i>
- Sample prefers functional attributes, e.g. ease of use, range; financial and social aspect less important - Functional customer cluster in the sample has the highest willingness to adopt	- Utility company is the preferred provider/aggregator - Provide public charging network	- Sample prefers to own an EV, bidirectional charger and charge at home - Revenues through sales of EVs, bidirectional charger, electricity, grid regulation

Source: R. Bohnsack, R. Van den Hoed, H. Oude Reiner, “Deriving vehicle-to-grid business models from consumer preferences”, EVS28, May 2015

V2G is not a quick charging based concept, on the contrary, most of the studies carried out in the matter are based on the vehicle providing services to the grid when parked, and, as discussed in previous sections, nowadays (and probably in the future), the EVs normally use slow charging in that situation (at home or at workplace). However, the advantages that quick charging can offer (basically, high power availability for a short period of time) have been explored in several pilot projects in USA and Japan, focusing on the services they can offer against disasters and emergency situations.

<sup>57</sup> California Independent System Operator

<sup>58</sup> R. Bohnsack, R. Van den Hoed, H. Oude Reiner, “Deriving vehicle-to-grid business models from consumer preferences”, EVS28, May 2015



A further study on the V2G concept is being conducted by the sister IEA IA-HEV Task 28, “Home, Grids and V2X technologies”<sup>59</sup>.

---

<sup>59</sup> <http://www.ieahev.org/tasks/home-grids-and-v2x-technologies-task-28/>

## 7. Situation of Quick Charging Technology

In this section, an overview of the different initiatives concerning the deployment of quick charging infrastructures carried out in the USA, Japan and, particularly, in Europe is presented. Public policies and programmes (incentives, subsidies, funding) and the legal framework at international, national, regional and local level are explored, with a particular focus on those cases discussed during the four task meetings or mentioned in the survey.

There is not a global approach in the deployment of the charging infrastructure, either in the location of the EVSE – residential, workplace, street, commercial areas, along the highways – or in the charging technologies (slow or quick conductive charging, inductive charging, battery swapping). Therefore, initiatives, policies, programmes and public regulation concerning this topic are not homogeneous, even within the European Union.

Several issues are to be taken into account when deploying a quick charger. Concerning site selection and equipment installation, issues such as site lease agreements, site host concerns, site suitability, utility connections and coordination, permitting and city ordinances are important. Furthermore, there are several operational issues that also need to be observed, such as demand charges, communications, payment methods and maintenance (cleaning, snow removal...).

The stakeholders that participated in the survey were asked about the most important issues to be taken into account when developing a quick charging EV infrastructure strategy. The most important one was, by far, the interoperability of the elements of the system, followed by a careful selection of the location of the infrastructures, having in mind the role of QC in alleviating the range anxiety<sup>60</sup>.

Much work has been done precisely in the development of strategies for an optimal and effective deployment of QC infrastructures, being most of them based on drivers patterns and behaviour and demographics data to evaluate charging demand. Many examples of this can be found in California: the Metropolitan Transportation Commission in the San Francisco Bay Area (MTC) derived trips by potential EV drivers based on their transportation demand model and used it to choose locations for QC stations<sup>61</sup>; the Sacramento Area of Council of Governments evaluated location through the analysis of existing and forecast EV owner demographics, associated driving patterns and land uses<sup>62</sup>. Other administrations in the same State conducted similar studies.

---

<sup>60</sup> See graph A5 in Annex 1

<sup>61</sup> ICF. 2012, Bar Area and Monterey Bay Area Plug-in Electric Vehicle Readiness Plan. Available from: [http://www.pevcollaborative.org/sites/all/themes/pev/files/docs/ba\\_pev\\_plan.pdf](http://www.pevcollaborative.org/sites/all/themes/pev/files/docs/ba_pev_plan.pdf)

<sup>62</sup> SACOG. 2014, Approve Electric Vehicle Charging Infrastructure Funding Program. Available from: <http://www.sacog.org/calendar/2014/05/board/pdf/7-PEV.pdf>

The different approaches followed by different administrations make it difficult to compare them and develop a standard strategy. Furthermore, the studies that supported these strategies did not take into account long distance travel, thus ignoring the demand from outside the metropolitan areas, which may represent an important part of the demand for charging (up to 70% in Sacramento Metropolitan Area, for instance). The UC Davis is developing a model that uses long distance data and addresses demand coming from outside a metro region in the context of any battery size<sup>63</sup>.

A very thorough study in a similar line has been conducted in the University of Applied Science of Amsterdam<sup>64</sup>, where a group of researches has worked to characterise in detail the charging behaviour of several user types (residents, commuters, city visitors, taxi drivers and users of car sharing systems) in a real environment (the city of Amsterdam). The combination of these patterns with probabilistic estimation of preferred charging locations is a very sound starting point to make predictions on the utilization of those charging points and provides policy makers with a useful information to help them make strategic decisions to optimize the deployment of new charging infrastructure.

### **7.1. Approaches and goals in the development of charging infrastructures worldwide**

The countries involved in the Electric Vehicles Initiative (EVI)<sup>65</sup> have established specific targets in regards to the number of slow and quick chargers to be deployed on those countries by 2020<sup>66</sup>. The cumulative targets for these countries sum up approximately 6,000 quick chargers and 2.4 million of slow chargers. One country accounts for the biggest part of these targets: Japan. The Government intends to deploy 5,000 quick chargers and 2 million slow chargers by the end of the decade. The United States, in turn, conducted a nationwide demonstration project in 2014 that involved the deployment of 22,000 chargers, 350 were quick chargers.

In Europe, each country has established their targets with different levels of ambition: the Netherlands, for instance, aims to have 20,000 slow chargers and 100 quick chargers by 2015. At EU level, different initiatives have been developed or are in the agenda for supporting the deployment of EV and its related infrastructures. Particularly relevant for quick charging (and the rest of the infrastructures) is the Clean Power for Transport

---

<sup>63</sup> W. Ji, M. Nicholas, G. Tal. 2014, submitted August 1. Electric Vehicle Fast Charger Planning for Metropolitan Planning Organizations: Adapting to Changing Markets and Vehicle Technology. *In Transportation Research Board Conference 2015 Forthcoming*. Washington D.C.

<sup>64</sup> J. Helmus, R. van den Hoed, “*Unraveling User Type Characteristics: Towards a Taxonomy for Charging Infrastructure*”, EVS28, May 2015

<sup>65</sup> Canada, China, Denmark, Finland, France, Germany, India, Italy, Japan, the Netherlands, Portugal, South Africa, Spain, Sweden, the United Kingdom and the United States

<sup>66</sup> Global EV Outlook – Understanding the EV Landscape to 2020, Apr 2013

package<sup>67</sup> and the Directive 2014/94/EU on the deployment of alternative fuels infrastructure, approved on September 2014.

The following figure shows the different approaches undertaken by three member countries of the Electric Vehicle Initiative and, the first two, active collaborators of the Task 20 through their national agencies: Japan, United States and The Netherlands.

**Figure 44:** Different EVSE Deployment Profiles (2012)

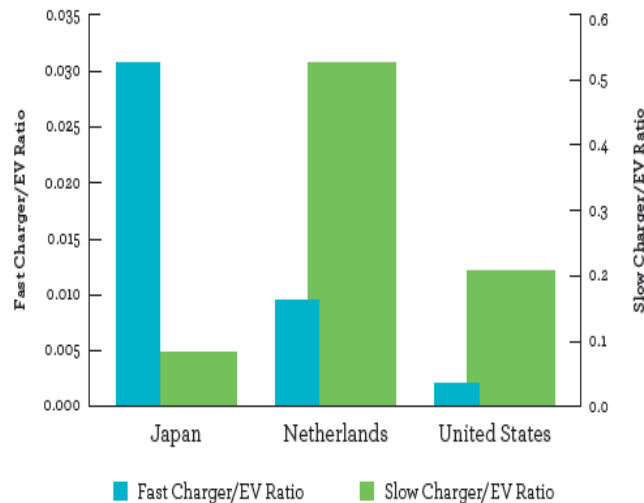

Source: EVI

The graphic shows the strong investment<sup>68</sup> of Japan in quick charging, unsurprising since CHAdeMO standard was developed in that country. Japan is the country with the highest amount of quick chargers installed (almost 3,000) but the emphasis is much lower in what concerns to slow charging infrastructure. On the other hand, the United States and, actually China and some countries in Europe (Spain or Italy), have supported a network much more based on slow chargers. Finally, other European countries, such as France or Netherlands are moving towards a network of infrastructures mixing quick and slow charging.

Stakeholders agree on the idea that there is not only one good solution and the adopted approach must be the result of a thorough analysis of the current situation, needs and opportunities in each country, taking into consideration several factors (demographics, cultural aspects, business cases for the different infrastructures, etc.).

Moreover, it is clear that a massive deployment of EVSE (both quick and slow chargers) is not the only leverage factor of a wider uptake of EVs, and so efforts should be focus on achieving the optimal EVSE/EV ratio. There has been much work and discussion on this, but it seems that ratios in the range of 0.08 to 0.3 for non-residential

<sup>67</sup> [http://ec.europa.eu/transport/themes/urban/cpt/index\\_en.htm](http://ec.europa.eu/transport/themes/urban/cpt/index_en.htm)

<sup>68</sup> This data does not include home installations of slow chargers

charging should be adequate<sup>69</sup>. As shown in the figure 45, EVI countries fall in this range for slow charging but not for quick charging. However, studies in the last years support the idea of electromobility strategies based on systems including much less quick chargers than slow chargers. As an example, according to a US study, only 100-200 quick chargers would be necessary for good geographic infrastructure coverage for the EV drivers in California<sup>70</sup>. This is very related to the business cases for the quick chargers, already mentioned in section 4 of this document.

**Figure 45: Non-residential EV/EVSE ratio**

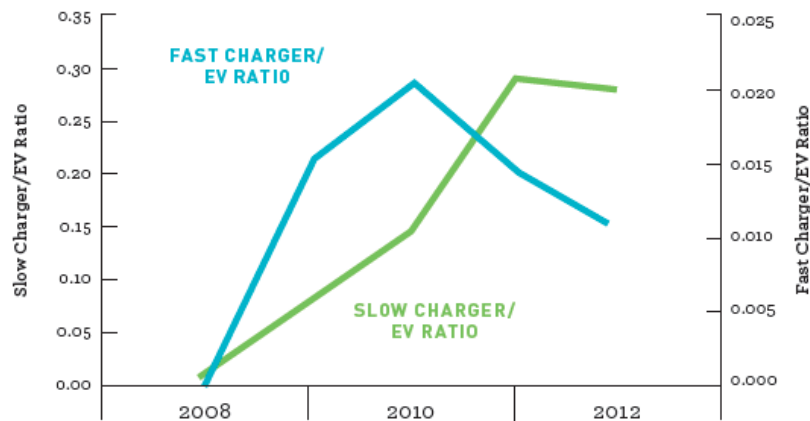

Source: EVI

Governments have a wide variety of options to support the deployment of the EV and they, set up measures both in the supply and the demand side. Concerning the EVSE, the most common action is to support their installation through taxes exemptions, financial incentives and, especially for quick chargers (due to their high cost), direct partial or full funding. This last option may include the purchase of the equipment and its installation. Concrete examples of national programmes on deploying EVSE, and particularly, quick chargers are provided within this section.

A summary of some of the measures that some governments have applied, both on the supply and the demand side is provided in Table 13. The measures presented in this table do not specifically referred to quick charging infrastructures, but they are generally included in actions with a wider scope. Furthermore, the table may not include initiatives at regional or local level.

<sup>69</sup> European Commission, Directive of the European Parliament and of the Council on the Deployment of Alternative Fuels Infrastructure, 2013/0012 (COD). International Council on Clean Transportation, “Vehicle Electrification Policy Study: Complementary Policies,” March 2011.

<sup>70</sup> Michael Nicholas, Gil Tal, Justin Woodjack, and Thomas Turrentine, “Fast Charging Network Dynamics in California: Modeling Travel Diary Data and Surveys,” Presentation at the Electric Vehicle Symposium 26, Los Angeles, May 6-9, 2012.

**Table 13: Selection of national policy initiatives (2013)**

EVI MEMBERS	FINANCIAL	INFRASTRUCTURE	RD&D
China	Purchase subsidies for vehicles of up to RMB 60,000.	---	RMB 6.95 billion for demonstration projects.
Denmark	Exemption from registration and road taxes.	DKK 70 million for development of charging infrastructure.	Focus on integrating EVs into the smart grid.
Finland	EUR 5 million reserved for vehicles participating in national EV development programme, ending in 2013.	EUR 5 million reserved for infrastructure as part of the national EV development programme, ending in 2013.	---
France	EUR 450 million in rebates given to consumers buying efficient vehicles, with 90% of that amount from fees on inefficient vehicles. Remaining 10% (EUR 45M) is a direct subsidy.	EUR 50 million to cover 50% of EVSE cost (equipment and installation).	EUR 140 million budget with focus on vehicle RD&D.
Germany	Exemption from road taxes.	Four regions nominated as showcase regions for BEVs and PHEVs.	Financial support granted for R&D for electric drivetrains, creation and optimisation of value chain, information and communications technology (ICT), and battery research.
India	INR 100,000 or 20% of cost of vehicle, whichever is less. Reduced excise duties on BEV/PHEVs.	The National Mission for Electric Mobility will facilitate installation of charging infrastructure.	Building R&D capability through joint efforts across government, industry, and academia. Focus on battery cells and management systems.
Italy	EUR 1.5 million for consumer incentives, ending in 2014.	---	---
Japan	Support to pay for 1/2 of the price gap between EV and corresponding ICE vehicles, up to YEN 1 million per vehicle.	Support to pay for 1/2 of the price of EVSE (up to YEN 1.5 million per charger).	Major focus on infrastructure RD&D.
Netherlands	Tax reduction on vehicles amounting to 10-12% net of the investment.	400 charging points supported through incentives.	Focus on battery RD&D (30% of 2012 spending).
Spain	Incentives up to 25% of vehicle purchase price before taxes, up to EUR 6,000. Additional incentives of up to EUR 2,000 per EV/PHEV also possible.	Public incentives for a pilot demonstration project. Incentives for charging infrastructure in collaboration between the national government and regional administrations.	Five major RD&D programmes are operational with incentives for specific projects.
Sweden	EUR 4,500 for vehicles with emissions of less than 50 grams of CO <sub>2</sub> /km. EUR 20 million for 2012-2014 super car rebate.	No general support for charging points besides RD&D funding (EUR 1 million in 2012).	EUR 2.5 million for battery RD&D.
United Kingdom	---	GBP 37 million for thousands of charging points for residential, street, railway, and public sector locations. Available until 2015.	The UK Technology Strategy Board has identified 60 collaborative R&D projects for low-carbon vehicles.
United States	Up to USD 7,500 tax credit for vehicles, based on battery capacity. Phased out after 200,000 vehicles from qualified manufacturers.	A tax credit of 30% of the cost, not to exceed USD 30,000, for commercial EVSE installation; a tax credit of up to USD 1,000 for consumers who purchase qualified residential EVSE. USD 360 million for infrastructure demonstration projects.	2012 budget of USD 268 million for battery, fuel cell, vehicle systems and infrastructure R&D.

Source: EVI

One of the main instrument public authorities have to support quick charging is legislation. In this regard, Task 20 participants were asked about how adequate the existent framework is in their countries. Again communications were pointed out as a major issue for QC: there seems to be a general lack of regulation in this respect. On the other hand, the regulatory framework for grid quality, general requirements or electromagnetic compatibility requirements is considered adequate.

## 7.2. Actions at EU level

Concerning the policy framework at European level, the role of the European Commission is to help create a “strategic environment” for local policy making and for investments into e-mobility in an urban setting. In this line, the EC published its strategy concerning clean transport in the Communication on “Clean Power for Transport: A European Alternative fuels strategy” on January 2013<sup>71</sup>, aimed at replacing oil with alternative fuels in the transport sector and **building up the necessary infrastructure**. In this communication, the Commission proposed the uptake of a mix of different “clean” transport solutions, being the electrification of transport one of them. The Commission highlighted the lack of recharging points (worsen by the inexistence of a common plug at that time) as one of the barriers for a wide deployment of EVs in Europe and pointed out the absence of strategic plans by most of the member states to solve this issue.

The main instrument that the Commission has developed to overcome that situation and boost the uptake of EVs was the Directive “on the deployment of alternative fuels infrastructure”<sup>72</sup>. This Directive, adopted on September 2014, requires Member States to develop and submit a national policy framework on EV charging infrastructures and includes the obligation for them of ensuring the deployment of sufficient publicly available charging points by 31<sup>st</sup> December 2020, at least in urban/suburban agglomerations. The target on the number of charging points should be set up taking into account the number of EVs expected to be registered by 2020 (8-9 million in the EU). As an indication, the Directive recommends to have at least 1 publicly available recharging point every 10 registered vehicles. Concerning the different types of EV charging infrastructure, the Directive allows free decision to the Member States for concentrating their efforts in slow or quick charging technologies (defined in the Directive as High power recharging points that allows for a transfer of electricity to an EV with a power of more than 22 kW, regardless AC or DC).

The Commission estimates that the investment necessary to build-up the alternative fuels infrastructure is € 10 billion<sup>73</sup>. The EC does not envisaged that all that money comes from public funding, but suggests the Member States to include in their policy frameworks different policy tools to leverage private funding: building permissions, concessions, procurement regulations, access and charging regulations and nonfinancial incentives. However, Member States are free to include in their legislation/ policy packages any measure they estimate effective to achieve the goals of the EU strategy. Anyways, the Commission reminds that European public funding is available to help build-up the charging infrastructure: TEN-T funds, Cohesion and Structural Funds and the European Investment Bank.

---

<sup>71</sup> COM (2013) 17

<sup>72</sup> Directive 2014/94/EU

<sup>73</sup> This includes electricity but also hydrogen, biofuels, natural gas and LPG

Other very relevant issue identified in the Strategy and addressed in the Directive is the development of common technical specifications in the Union for the interface between EVs and recharging points, back then considered one of the heaviest impediments to a broader market uptake of EVs in Europe. Therefore, the Directive establishes that Member States, that need to transpose the directive by November 2016, shall ensure that DC quick charging points deployed or renewed as from 18 November 2017, comply at least, for interoperability purposes, with connectors of the combined charging system “Combo 2” as described in the standard EN 62196-3. This does not forbid the deployment of charging points complying with other standards, such as CHAdeMO, as it was feared by some OEMs and countries with an important charging network based on this standard. On the contrary, the Directive establishes that EVs already in circulation before the entry into force of the Directive should be able to recharge, even if they were not designed to be charged with Combo 2 compliant chargers.

The Directive also addresses other important issues such as the need of making available the information about the location of public infrastructures to the public, the benefits of a joint deployment of recharging infrastructures and smart metering or the EVSE operators being able to purchase electricity from any Union electricity supplier.

Moreover, the Council has called for further actions towards the electrification of transport and has invited the European Commission to further examine instruments and measures for a comprehensive and technology neutral approach for its promotion also after 2020<sup>74</sup>.

Finally, the European Authorities also support EV stakeholders in addressing the technological challenges for a widespread deployment of EV in the Union, especially through the research programme Horizon 2020. Research and innovation actions related to EVs are funded by the European Commission within the Transport Challenge<sup>75</sup> (€6,339 million for the period 2014-2020) and the Energy Challenge (€5,931 million for the period 2014-2020) of the aforementioned programme. The European Commission develops this programme in collaboration with the relevant stakeholders, who have jointly develop several technological roadmaps<sup>76,77,78</sup>-very in line with the priorities that participants of Task 20 have identified during the task meetings and in the survey.

### 7.3. Specific national programmes

This section presents the specific initiatives of four countries in supporting the deployment of quick charging infrastructures: Estonia, Ireland, the United States of America and Japan. They have all been directly or indirectly involved in the activities of

---

<sup>74</sup> [http://www.consilium.europa.eu/uedocs/cms\\_data/docs/pressdata/en/ec/145397.pdf](http://www.consilium.europa.eu/uedocs/cms_data/docs/pressdata/en/ec/145397.pdf)

<sup>75</sup> <https://ec.europa.eu/programmes/horizon2020/en/h2020-section/smart-green-and-integrated-transport>

<sup>76</sup> <http://www.egvi.eu/uploads/Modules/Publications/ppp-egvi-roadmap-oct2013.pdf>

<sup>77</sup> [http://www.egvi.eu/uploads/Modules/Publications/electrification\\_roadmap\\_web.pdf](http://www.egvi.eu/uploads/Modules/Publications/electrification_roadmap_web.pdf)

<sup>78</sup> [https://setis.ec.europa.eu/system/files/Towards%20an%20Integrated%20Roadmap\\_0.pdf](https://setis.ec.europa.eu/system/files/Towards%20an%20Integrated%20Roadmap_0.pdf)



Task 20 and their cases have been selected for representing different possible support strategies for creating a network of infrastructures in very diverse countries in terms of geography, population, GDP, etc.

### Estonia

One of the most well known initiatives at national level for deploying a nationwide network of public quick charging infrastructures was carried out in Estonia. The Estonian Electromobility Programme (ELMO), responsible of this initiative, installed 165 CHAdeMO quick chargers for a 1.3 million inhabitants country (roughly 1 quick charger for every 8,000 people). The distribution of the chargers ensured at least one quick charger installed in each town of the country and in the larger villages and within stations in all the main highways at a minimum distance of 40 to 60 km, thus providing a really extensive charging service to the EV drivers. The coverage of the network is shown in the figure below:

**Figure 46:** Estonian national charging network

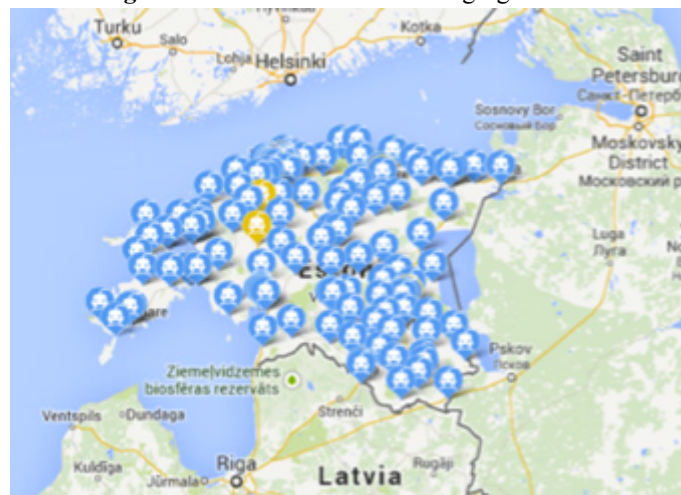

Source: ELMO

The deployment of the network was financed through the ETS system: the Government of Estonia sold the excess CO<sub>2</sub> emissions capacity to the Mitsubishi Motors Corporation. The revenues were invested on the installation of the quick chargers, the purchase of 500 Mitsubishi electric vehicles iMiEVs for the public fleet, a funding programme for the installation of AC slow chargers at home (1,000 euros grant per charger) and another funding programme aim at incentivize the population to buy full-electric vehicles, based on subsidies for a value of 18,000 euros or the 50 per cent of the cost of the vehicle.

### Ireland

In Ireland, the Electricity Supply Board (ESB), state-owned premier electricity utility, has been appointed for the rollout of an extensive EV charging network. Started in 2010, the ESB has already deployed 1,200 public infrastructures across the island (in collaboration with a consortium led by the Department for Regional Development and

the Department of Environment for the infrastructures in Northern Ireland), including quick charging. ESB is also in charge of implementing the supporting IT and payment systems to open accessibility for all energy supply companies and all types of electric cars: supporting IT systems and payment methods will be standard in both the Republic of Ireland and Northern Ireland, to allow drivers to pay and charge seamlessly regardless the location.

The charging network has been partially funded by European Funds (EU Trans-European Transport Network – TEN-T programme) and had a budget of 4.2€ million. The Northern Ireland part received 850,000 pounds from the UK Government (through a tender process) and raised other 800,000 among the members of the (public-private) consortium. A map showing the status of the charging network as of June 2013 can be found below:

**Figure 47:** Irish national charging network deployed by ESB



Source: ESB

The quick chargers deployed in Ireland comply with standard CHAdeMO and have been strategically placed along main inter-urban routes to allow EV drivers to travel long distances around Ireland. Moreover, quick chargers have also been installed in urban and suburban areas so as to ensure that every EV has always access to a quick charger at a maximum distance of 60 km. In total, 100 quick chargers in Ireland and 14 in Northern Ireland will be installed.

The public deployment and operation of infrastructures by ESB are also accompanied by other measures to incentivize the uptake of EV in the country, such as subsidies to the purchase of EVs by the Irish Government or the free installation of private

infrastructures (AC slow charging) at home/ workplace to the first 2,000 EV consumers to register into the recharging service offer by the utility.

## United States

In the United States, a large number of public incentives, laws and regulations and programmes at Federal State and local level have been developed in order to foster the deployment of public and private charging infrastructures in the country. As of March 2015, the public charging infrastructure in the country counts with more than 9,000 electric stations with more 23,000 charging outlets<sup>79</sup>. Around 10% of this infrastructure corresponds to DC quick charging, operated by 12 different EV charging network operators. The following map shows the location of these stations, mainly in the East and West coasts of the country:

**Figure 48:** Quick charging points in the United States

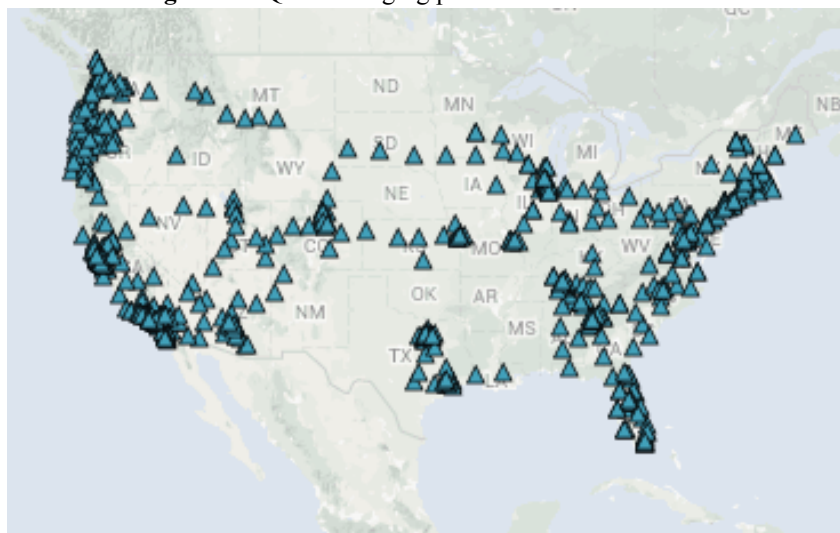

Source: US Department of Energy

Out of the 2,568 quick charging points available in the country, 1,425 are CHAdeMO compliant (55%) and 281 are SAE COMBO (COMBO 1) compliant (10%), being the rest Tesla Superchargers.

As mentioned before, particular private organizations are also working for a wider deployment of publicly available recharging infrastructures in the US. An example of this is the initiative launched at the beginning of 2015 by two OEMs (Volkswagen of America and BMW of North America) and the largest EV charging network operator, ChargePoint, for the creation of more express charging corridors in both the East and West Coast, consisting of an initial phase of 100 DC charging points deployed by the end of 2015<sup>80</sup>. The chargers will be installed both in urban and inter-urban areas, strategically spaced at a maximum of 80 km apart, and will include up to two 50 kW DC quick chargers (SAE COMBO and CHAdeMO) and 24 kW DC Chargers (only SAE

<sup>79</sup> Information provided by the US Department of Energy “Alternative Fuels Data Centre”

<sup>80</sup> <http://www.greencarcongress.com/2015/01/20150122-vwbmwcp.html>

Combo). The partners hope for additional private and public funding to expand this program nationally.

## Japan

The government of Japan published in 2010 its Next-Generation Vehicle Plan for supporting the development and production of advanced eco-friendly vehicles. The plan was divided in six sub-plans: overall plan, batteries, rare metals, systems, international standards and infrastructure.

The infrastructure plan established the target of installing 2 million of “normal chargers” (AC) and 5,000 DC quick chargers by 2020, mainly in the so-called “EV/PHV towns”. For achieving this objective, the Ministry of Economy, Trade and Industry (METI) develop the Infrastructure Development Roadmap with the following main points:

- At the market preparation stage, the country will intensively and systematically build infrastructure.
- This will be followed by the diffusion stage, based on EV/PHV town best practices handbook (including business models)

The METI selected a series of cities in which local governments were taking the lead in the penetration of PHEV to be used as model regions (EV/PHV towns). These local governments had to define their targets, develop their plan specification, plan execution and share their results, out of which the best practices handbook will be created. To support the cities and achieve the Government targets, the METI created a fund for subsidize the charging infrastructures and develop some guidelines for the installation of this infrastructure.

The fund had a budget of USD 1.14 billion and could cover up to 2/3 of purchasing costs of the charging station and 100% of the installation costs. The fund is fully aligned with the “deployment plans” of the EV/PHV towns, so higher subsidy rate is available for infrastructures to be deployed based on these plans. The following figure shows the scheme chosen by the Government to provide this support:

**Figure 49:** Subsidies scheme of quick charger in Japan

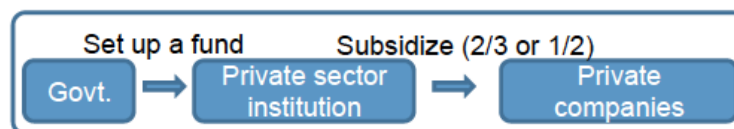

Source: METI

Concerning the guidelines for the EV/PHV towns (and Highway Public Corporations), the METI developed a model plan with procedures for optimally placing charging stations in large cities, main interurban roads and medium and small cities. An overview of the model plan is shown in the figure 50.

Figure 50: Model Plan for deploying EV chargers

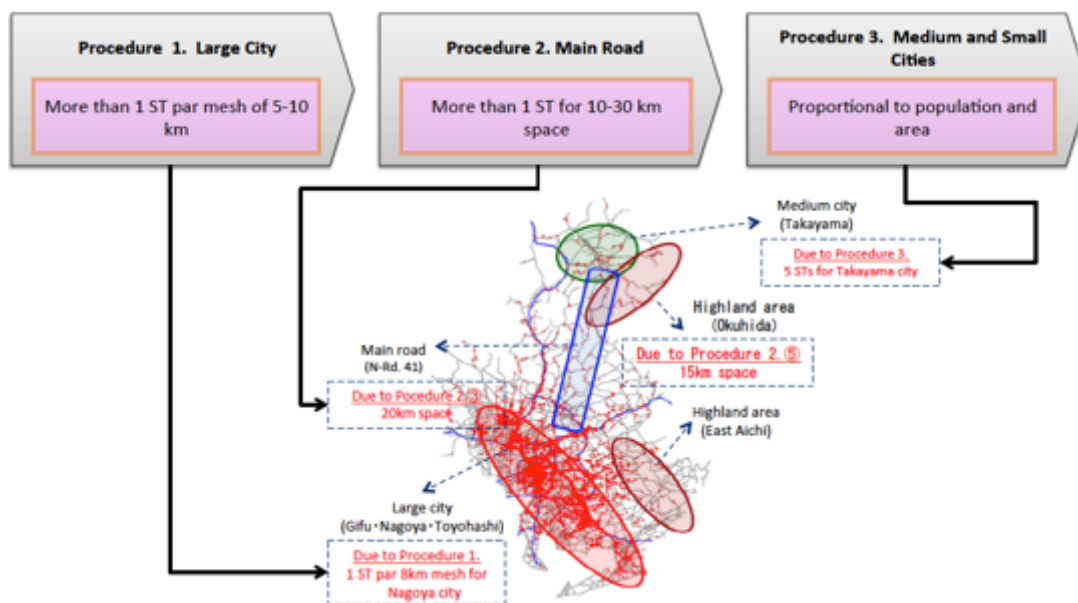

Source: METI

Today Japan is the country with the largest quick charging infrastructure network, with over 3,000<sup>81</sup> CHAdeMO chargers deployed and hosts the headquarters of several EV manufacturers.

#### 7.4. Future of Quick Charging technologies

The future of quick charging technologies has been widely discussed in the four face-to-face meeting organized by Task 20 and the main conclusions on the trends and recommendations have been presented and highlighted throughout this document.

In order to deepen in this area, the participants of the online survey were asked to provide their vision on the evolution of certain applications and uses considered important to facilitate the deployment of QC envisaged for the period 2015-2030. The results of the survey in this issue are presented in figure 51.

The participants consider that most of these concepts, such as remote management of the charger, V2H systems and the use of “second-life” batteries will remain in a pre-commercial stage at least until 2020. Other uses, such as quick charging for assisting in energy management and load levelling for the residential and commercial sectors is not expected to run until 2025 or 2030, provided an appropriate regulatory framework is put in place.

The large deployment and operation of certain V2X technologies using QC, such as V2G is not expected until 2025, and others like Vehicle-to-Vehicle (V2V) systems are foreseen to need much more research and development before they are ready for commercialization.

<sup>81</sup> As of May 2015

**Figure 51:** Roadmap of uses and applications that might facilitate the deployment of QC

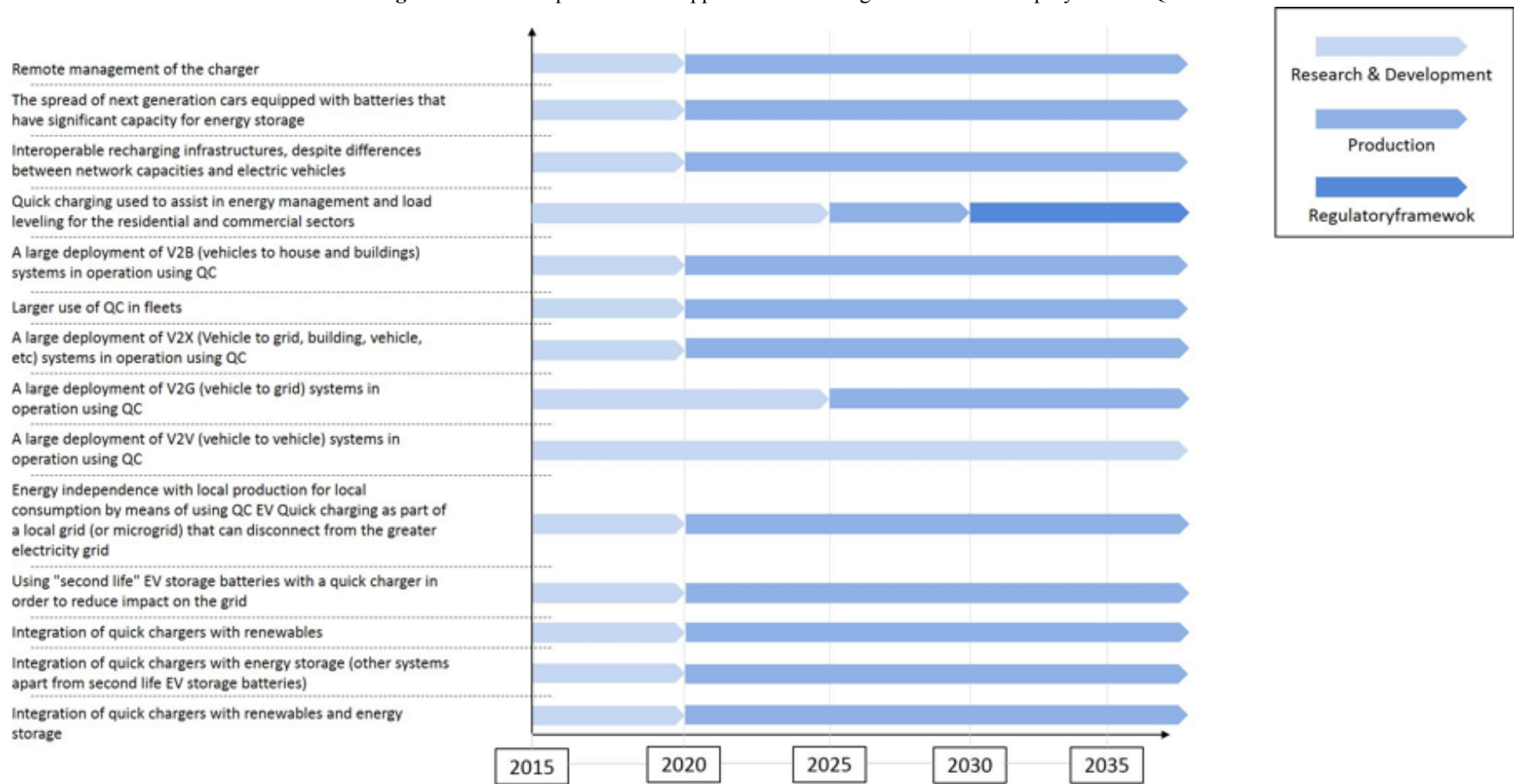

Source: Online survey

## ANNEX 1: IEA SURVEY RESULTS

### PART 1: BUSINESS MODELS

**Graph A1**

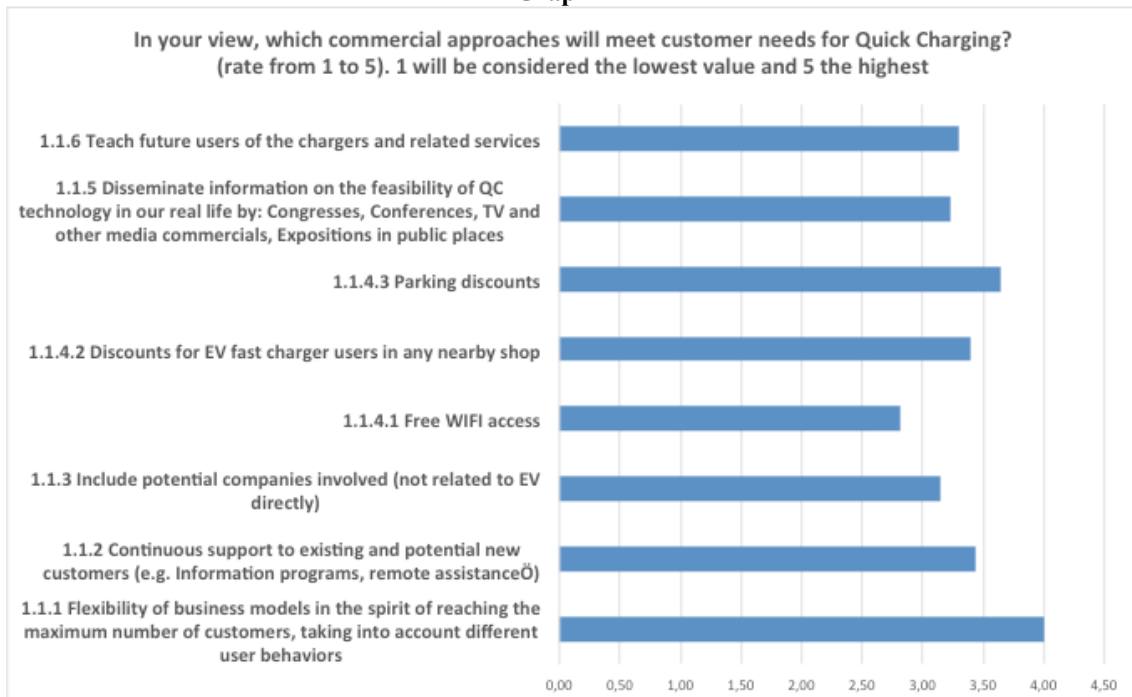

**Graph A2**

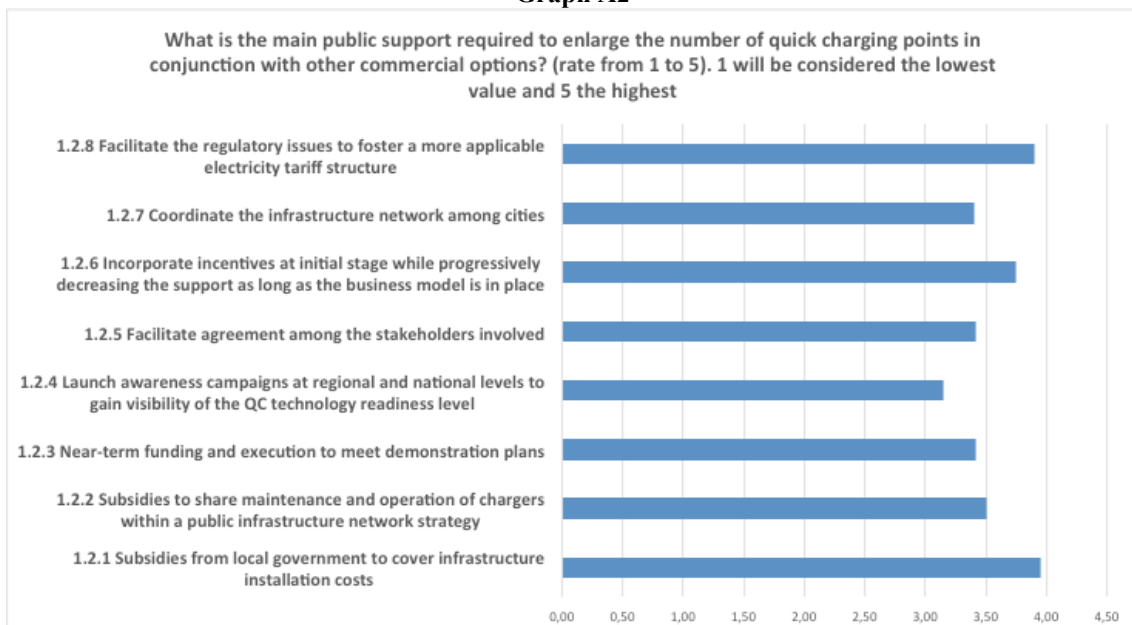

**Graph A3**

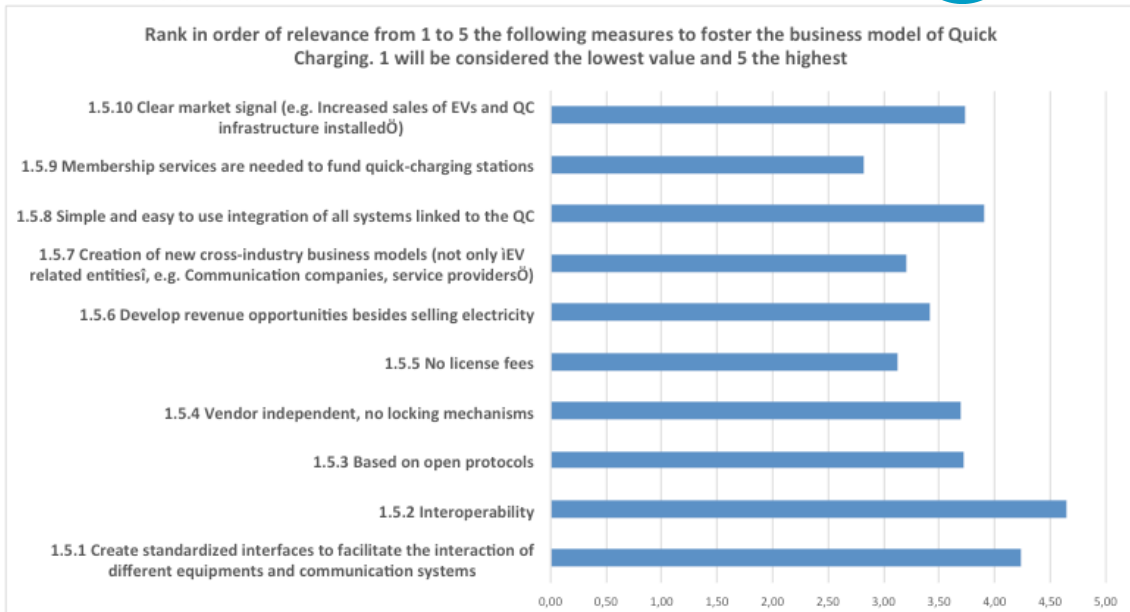

Graph A4

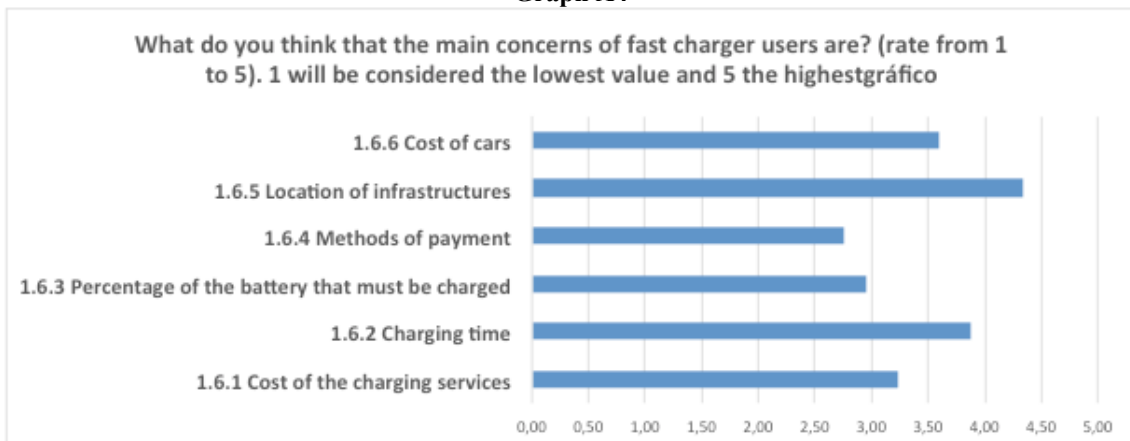

## PART 2: CHARGER INFRASTRUCTURE

Graph A5

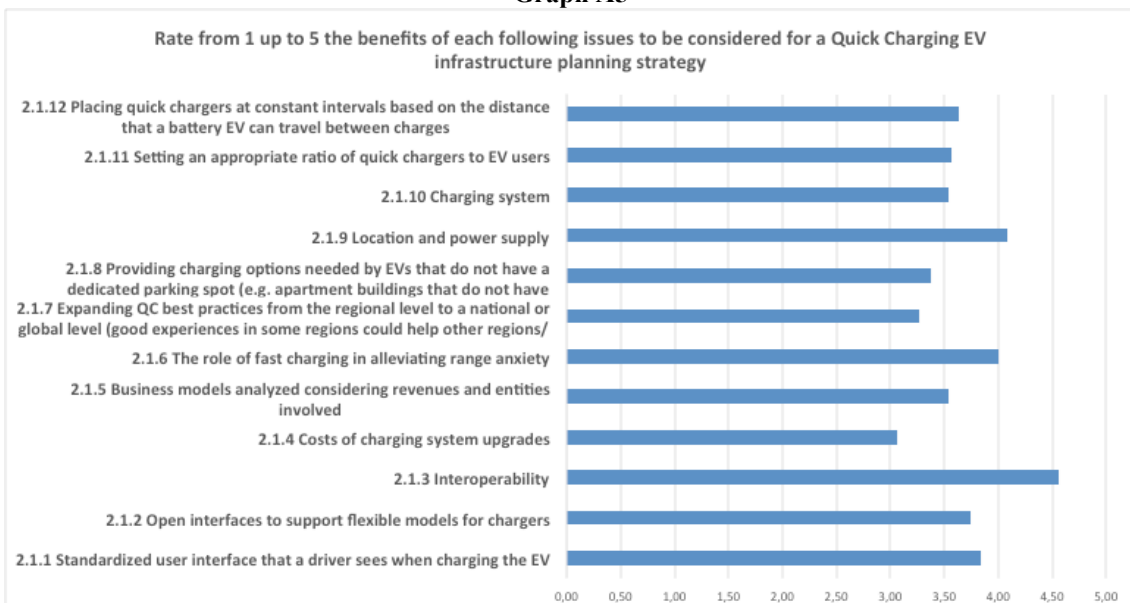



**Graph A6**

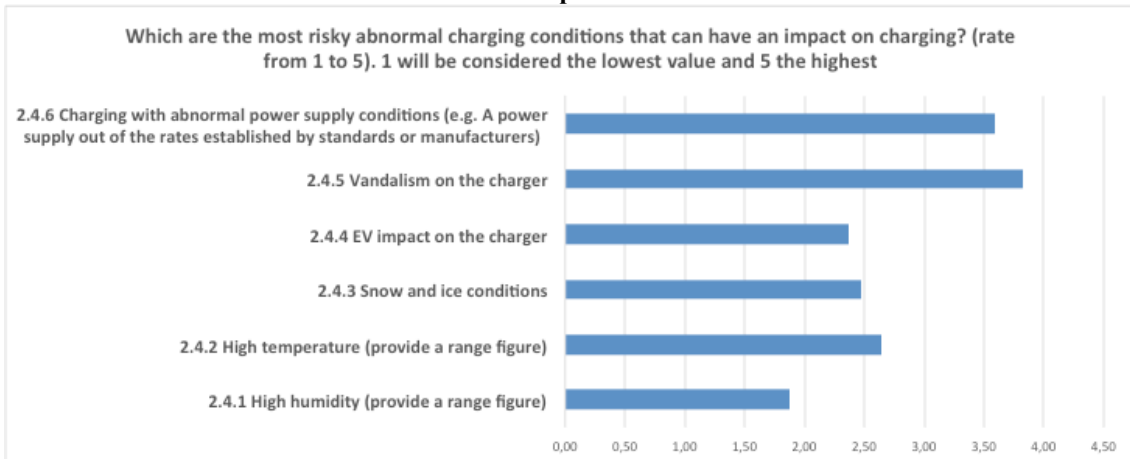

**Graph A7**

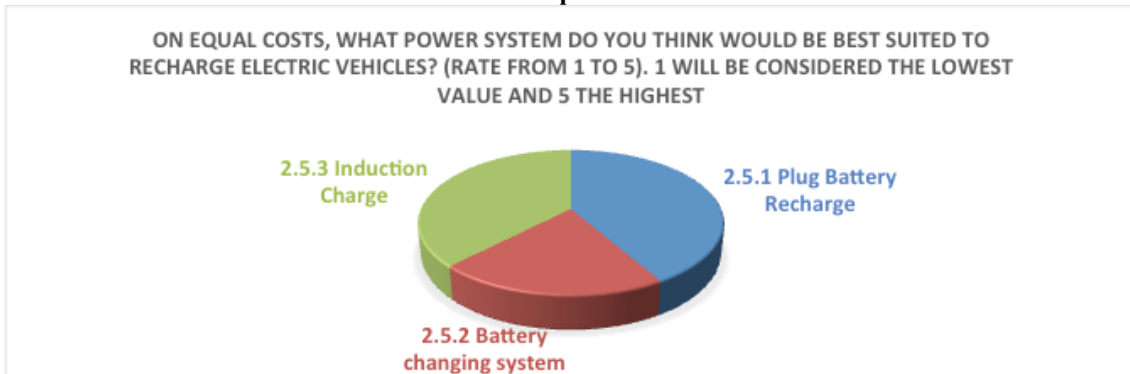

### PART 3: OEM

**Graph A8**

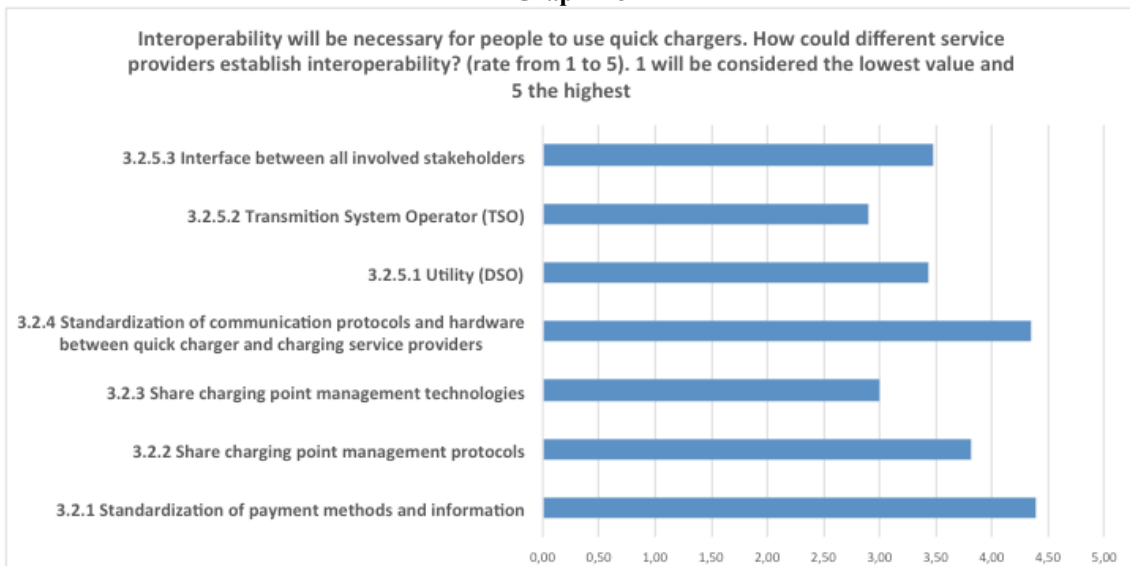

**Graph A9**

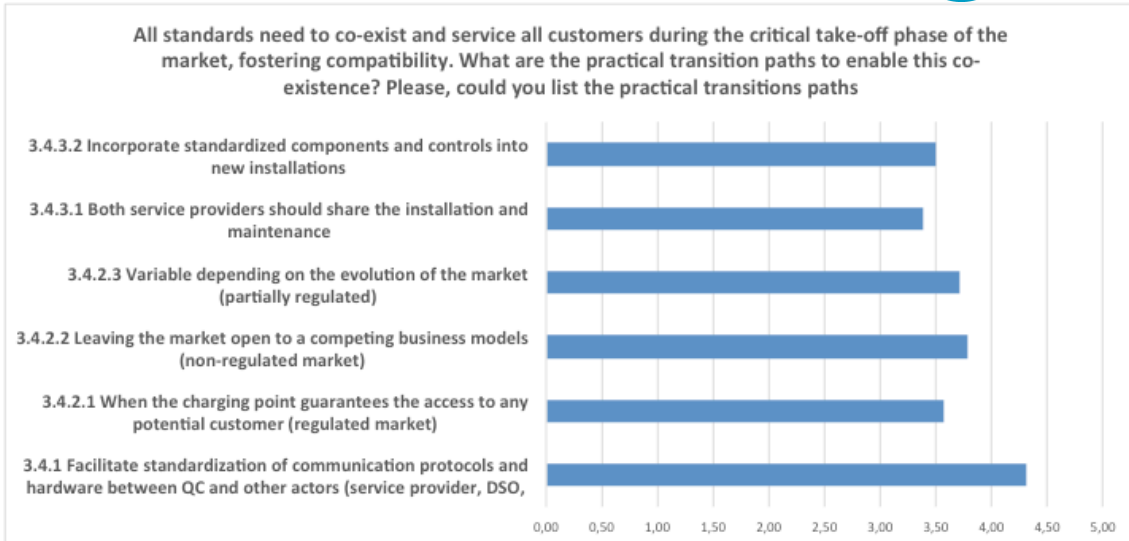

## PART 4: GRID IMPACT

**Graph A10**

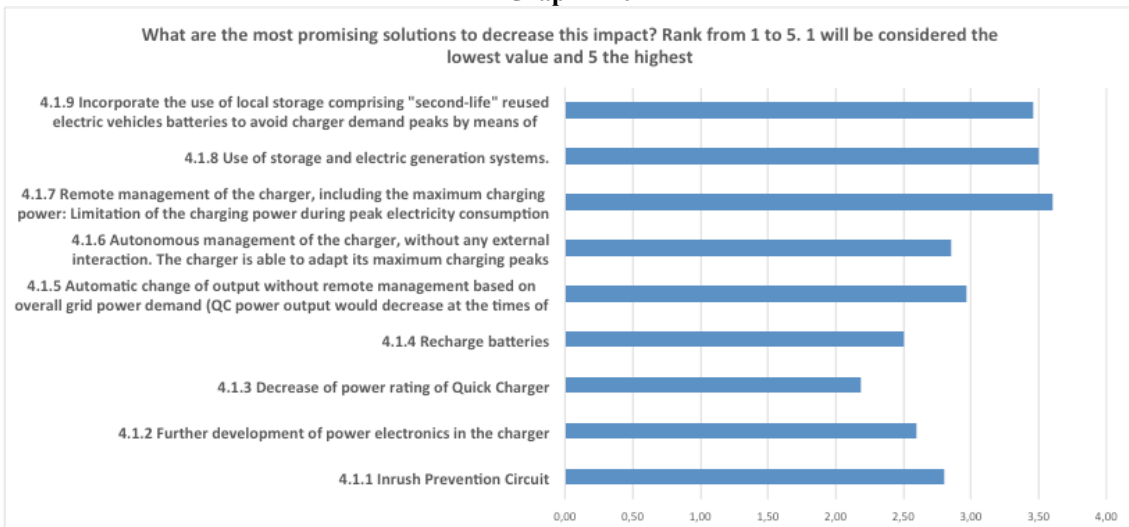

**Graph A11**

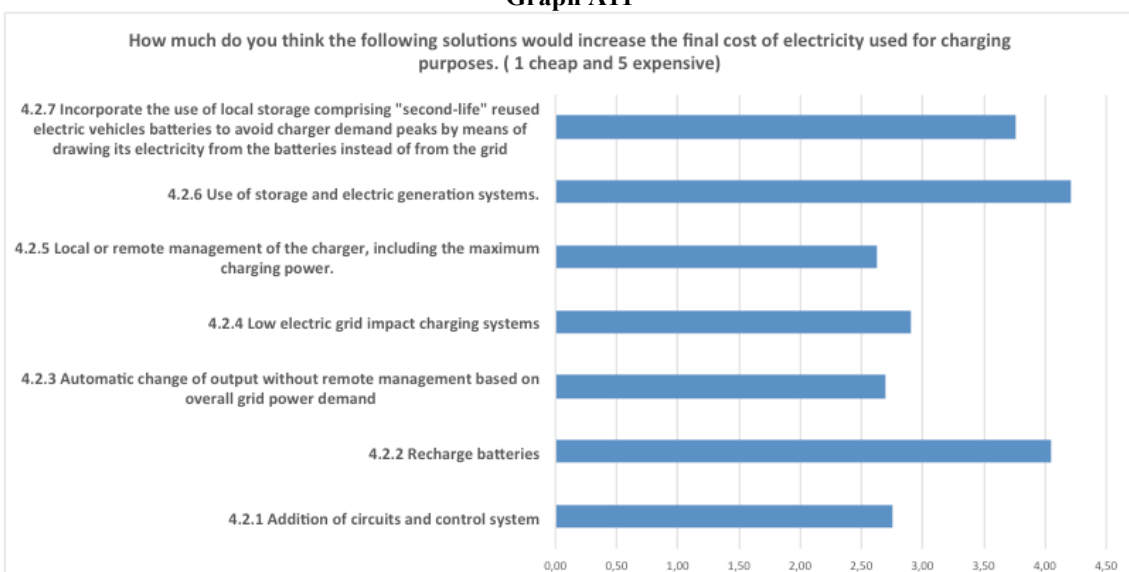

**Graph A12**

IN TERMS OF POWER QUALITY, WHAT IS THE ROLE OF THE FOLLOWING BARRIERS TO BE FURTHER STUDIED (RATE FROM 1 TO 5) .. 1 WILL BE CONSIDERED THE LOWEST VALUE AND 5 THE HIGHEST



**Graph A13**

REMOOTE MANAGEMENT MIGHT DECREASE THE GRID IMPACT THROUGH: (RATE FROM 1 TO 5). 1 WILL BE CONSIDERED THE LOWEST VALUE AND 5 THE HIGHEST

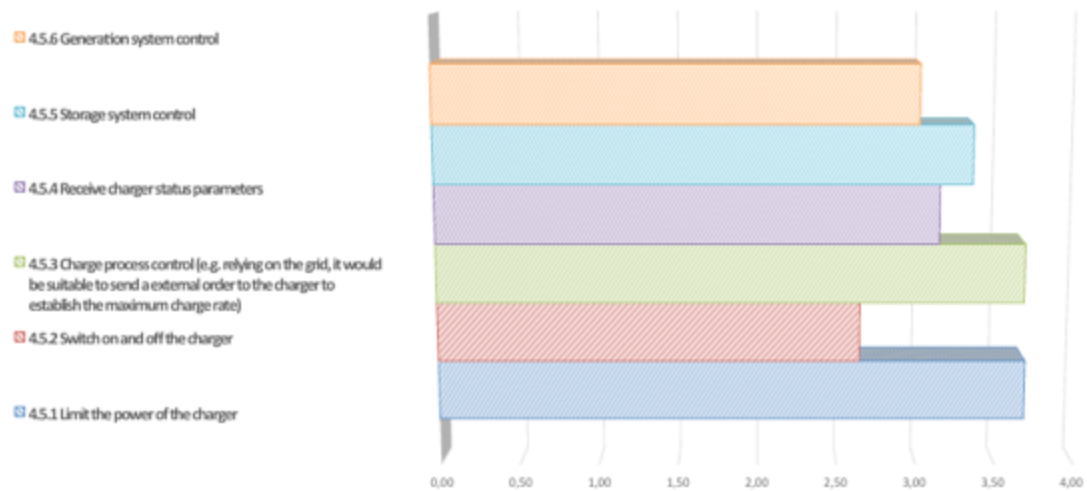

**Graph A14**

WHEN USING REMOTE MANAGEMENT OF THE FAST CHARGERS, WHAT ENTITY'S ORDERS SHOULD BE THE MOST IMPORTANT ONES (RATE FROM 1 TO 5). 1 WILL BE CONSIDERED THE LOWEST VALUE AND 5 THE HIGHEST

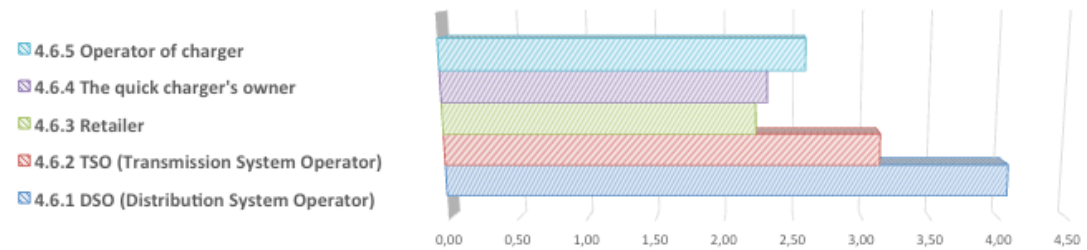

## LIST OF PARTICIPANTS IN THE QUICK CHARGING SURVEY

ABB	Lithium Balance
AeroVironment, Inc.	Michigan State University
Argonne National Laboratory	Ministry of Economy, Trade and Industry (Japan)
BMW Group	MisterGreen Electric Lease
California Energy Commission	Mitsubishi Heavy Industries
CHAdEMO Association	Netherlands Enterprise Agency (RVO.nl)
Charging Network Development Association, LLC	Newcastle University
Charging Network Development Organization, LLC	Nissan Motor Co. Ltd.
China Automotive Technology & Research Center (CATARC)	Nissan North America
Chrysler Group LLC	Northeast Utilities Service Company
Clemson University	NREL
CSA Group	Projekt Management Juelich
Daimler AG	San Diego Gas and Electric
DLR	Selcan
DTU	Self-employed
ENEA	Studio Equinocio
European Commission JRC IET	Swiss eMobility
FCA SpA	Swiss Forum for electric mobility
Ford Motor Company	Tokyo Electric Power Company
Gedas Iberia	Toyota
General Motors	Toyota Motor Europe
HELLA	TÜV SÜD AG
Hydro-Québec	University of Zaragoza
ICCT	Urban Foresight
Japan Charge Network Co, Ltd	Volvo Group Trucks Technology

## ANNEX 2: RELEVANT STANDARDS FOR QUICK CHARGING

There is a considerable effort from the different organizations involved in the deployment of the EV on the development of international standards for this sector. The main standards related to the quick charging of the EV batteries are presented below:

- General requirements for EV conductive charging:
  - **IEC 61851-1 (ed2.0):** Electric vehicle conductive charging system - Part 1: General requirements
  - **IEC 62196-1 (ed3.0):** Plugs, socket-outlets, vehicle connectors and vehicle inlets - Conductive charging of electric vehicles - Part 1: General requirements
- Standards that regulate AC Quick Charging:
  - **IEC 61851-21 (ed1.0):** Electric vehicle conductive charging system - Part 21: Electric vehicle requirements for conductive connection to an AC/DC supply
  - **IEC 61851-22 (ed1.0):** Electric vehicle conductive charging system - Part 22: AC electric vehicle charging station
  - **IEC 62196-2 (ed1.0):** Plugs, socket-outlets, vehicle connectors and vehicle inlets - Conductive charging of electric vehicles - Part 2: Dimensional compatibility and interchangeability requirements for AC pin and contact-tube accessories
- Standards that exclusively regulate DC Quick Charging:
  - **IEC 61851-23 (ed1.0):** Electric vehicle conductive charging system - Part 23: DC electric vehicle charging station
  - **IEC 61851-24 (ed1.0):** Electric vehicle conductive charging system - Part 24: Digital communication between a DC EV charging station and an electric vehicle for control of DC charging
  - **IEC 62196-3 (ed1.0):** Plugs, socket-outlets, vehicle connectors and vehicle inlets - Conductive charging of electric vehicles - Part 3: Dimensional compatibility and interchangeability requirements for DC and AC/DC pin and contact-tube vehicle couplers
- Standards that exclusively regulate inductive charging:
  - **IEC 61980-1 (Under development):** Electric vehicle wireless power transfer (WPT) systems- Part 1: General requirements.
  - **IEC/TS 61980-2 (Under development):** Electric vehicle wireless power transfer (WPT) systems - Part 2: specific requirements for communication between electric road vehicle (EV) and infrastructure with respect to wireless power transfer (WPT) systems
  - **IEC/TS 61980-3 (Under development):** Electric vehicle wireless power transfer (WPT) systems - Part 3 specific requirements for the magnetic field power transfer systems.
- Requirements for the communications interface:
  - **ISO 15118-1 (ed1.0):** Vehicle to grid communication interface - Part 1: General information and use-case definition.
  - **ISO 15118-2 (ed1.0):** Vehicle to grid communication interface - Part 2: Network and application protocol requirements.

- **ISO 15118-3 (Under development):** Vehicle to grid communication interface - Part 3: Physical and data link layer requirements.
- **ISO/CD 15118-6 (Under development):** Vehicle to grid communication interface - Part 6: General information and use-case definition for wireless communication
- **ISO/AWI 15118-7 (Under development):** Vehicle to grid communication interface - Part 7: Network and application protocol requirements for wireless communication.
- **ISO/AWI 15118-8 (Under development):** Vehicle to grid communication interface - Part 8: Physical layer and data link layer requirements for wireless communication